

Important Safety Considerations

I. Operating environment safety:

1. Make sure the supply voltage is 180V-260V;
2. Never use the machine in an environment with high noise sources such as high-frequency welder;
3. The ambient temperature should be controlled at 5°C-45°C;
4. The ambient relative humidity should be controlled at 30%-95%;
5. Avoid direct sun shine;
6. Never use the machine in an environment with excessive dust and corrosive gas;

II. Installation safety:

1. Install the electric control box, operating box, pedal sensor and switch box correctly according to the instructions in the manual;
2. Install parts with power turned off;
3. Lay the power cable properly to prevent any damage caused by heating or squeezing;
4. The safety earth wire of sockets should be connected to the earth of the building reliably to prevent leakage current resulting in personal injury;
5. Foolproof design is adopted to the maximum extent for electric control plugs, and illustrations have been provided on patch panel. Make sure they are connected correctly.

III. Operation safety:

1. When the machine is started for the first time, operate it at a low speed, and check that the handwheel rotation direction is correct and the operation sound is normal;
2. Do not touch moving parts such as needle bar, handwheel and rotating shuttle, etc during operation;
3. When the machine is powered, do not conduct power operations such as plug in/unplug and box opening, nor touch live devices;
4. Make sure the air inlet at the bottom and the fan opening on the side of the electric box are not blocked;
5. In the first months, operate the machine at a low sewing speed (below 3,000rpm).

IV. Maintenance safety:

Turn off the power prior to the following operations:

1. Removing controller, motor, pedal sensor, operating box and power switch box, etc;
2. High voltage exists in the machine case, do not open the control box until the power has turned off for more than 10 minutes;
3. Replacing needle or rotating shuttle or threading, oiling;
4. Repairing or adjusting the machine or long time stand-by.

V. Maintenance regulations:

1. Maintenance must be performed by trained professionals;
2. The air inlet and outlet of the control box must be cleaned regularly;
3. Avoid collision or falling of control box and operating box, etc during handling, nor knocking the motor with a beetle, etc;
4. Parts used for maintenance must be supplied or approved by us.

VI. Warning symbols:



: Operation or safety precautions.

VII. Note:



2290S-SR/S/B types mainly differ in fabric feeding mode (with step motor, solenoid and mechanical lever respectively). Therefore, the relevant functions specified in the manual depend on the specific product type. For further information, consult the local dealer.

Contents

| | | | |
|---|-----------|--|-----------|
| I. Control box internal structure | 1 | 7.2 Overlapped sewing setting | 37 |
| II. Control box patch panel description | 1 | 7.3 Programmed sewing setting | 38 |
| III. Electrical specification | 2 | 8 Customization handling | 40 |
| IV. Installation | 2 | 8.1 Customized start point setting | 40 |
| 1 Control box installation | 2 | 8.2 Customization copy and delete | 42 |
| 2 Pedal sensor installation | 2 | 9 System management setting (M interface) | 43 |
| 3 Diagram after installation | 2 | 9.1 Universal parameter setting | 44 |
| V. Operation panel operation method | 3 | 9.2 Factory parameter restore | 46 |
| 1 Name and function of parts of operation panel | 3 | 9.3 Operation panel parameter setting | 46 |
| 1.1 Operating box | 3 | 9.4 System parameter setting | 46 |
| 1.2 Universal touch buttons | 4 | 9.5 Touch screen calibration setting | 47 |
| 2 Before sewing | 6 | 9.6 Test run | 47 |
| 2.1 Description of three data setting modes | 6 | 9.6.1 Sensor check test | 48 |
| 2.2 Setting needle max. zigzag width | 7 | 9.6.2 Output check test | 49 |
| 2.3 Setting reference line position | 7 | 9.6.3 Zero position check test | 50 |
| 2.4 Setting feeding volume limit | 9 | 9.6.4 Installation adjustment test | 51 |
| 3 Main interface description | 9 | 9.6.5 Stepping aging test | 52 |
| 4 Pattern selection | 10 | 9.6.6 Machine aging test | 53 |
| 4.1 Standard pattern selection | 10 | 9.7 Communication function | 54 |
| 4.2 Customized pattern selection | 12 | 9.7.1 Inserting memory card | 54 |
| 5 Pattern attribute setting | 13 | 9.7.2 Selecting transmission direction | 54 |
| 5.1 Straight stitch setting | 13 | 9.7.3 Operating box pattern selection | 55 |
| 5.2 2-point, 3-point and 4-point zigzag stitch setting | 14 | 9.7.4 SD card file selection | 56 |
| 5.3 Scallop setting | 16 | 9.8 Access setting | 56 |
| 5.4 Blind stitch setting | 18 | 9.8.1 Access setting | 57 |
| 5.5 T shape setting | 19 | 9.8.2 Access password revise | 57 |
| 5.6 Pattern 1 setting | 20 | 10 System information setting (I interface) | 58 |
| 5.7 Pattern 2 setting | 22 | 10.1 Software version inquiry | 58 |
| 5.8 Pattern 3 setting | 25 | 10.2 System operation monitor | 59 |
| 5.9 Pattern 4 setting | 27 | 11 Abnormalities | 59 |
| 5.10 Customized pattern setting | 29 | 11.1 Alarms | 59 |
| 6 Bar-tacking setting | 30 | 11.1.1 Customization synchronization | 59 |
| 6.1 Standard bar-tacking | 31 | 11.1.2 Non upper needle stop position alarm | 60 |
| 6.2 2-point shirring | 33 | 11.1.3 Data over limit alarm | 60 |
| 6.3 Customized bar-tacking | 35 | 11.1.4 Head lift alarm | 62 |
| 6.4 Comparison of bar-tacking for various patterns | 36 | 11.2 Troubles | 62 |
| 7 Sewing mode setting | 36 | VI. Operating box parameter table | 63 |
| 7.1 Free sewing setting | 36 | VII. Advanced parameter table | 63 |
| | | VIII. List of troubles | 70 |

I. Control box internal structure

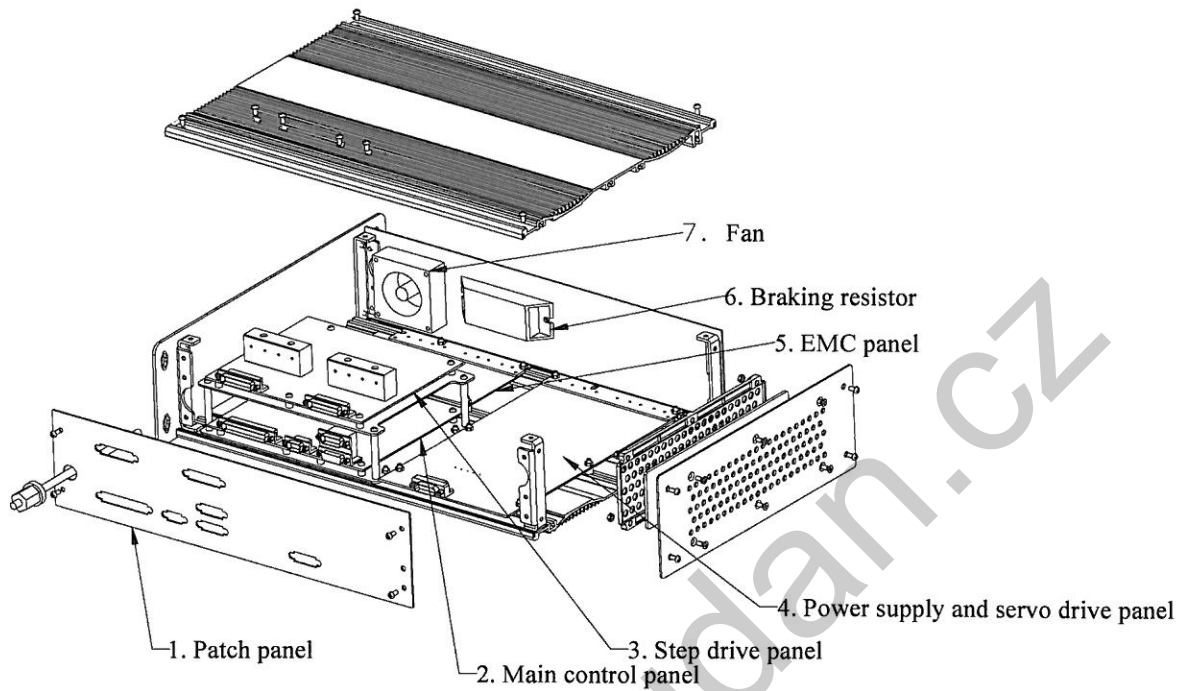

II. Control box patch panel description

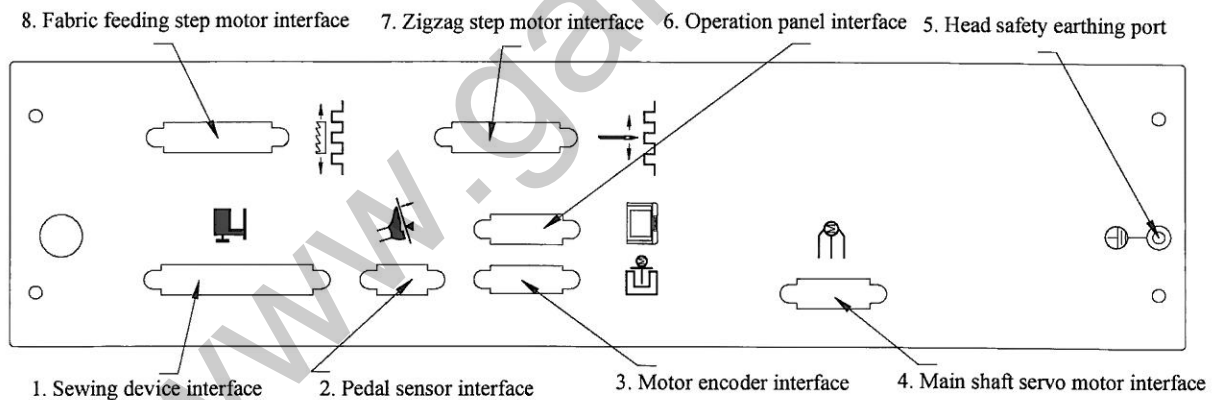

Note: 1. Both the fabric feeding step motor and the zigzagging motor use DB25 sockets, check them carefully to prevent confusion.

2. To prevent static disturbance and electric leakage accidents, make sure the head and the controller are connected reliably through the safe grounding port of the head.

III. Electrical specification

| | | |
|-----------------------|-----------------|------------------|
| Supply voltage | ☐ 95V ~ 125V AC | ☑ 180V ~ 260V AC |
| Power | 600 VA | |
| Number of phases | Single phase | |
| Frequency | 50HZ/60HZ | |
| Operation temperature | 5°C-40°C | |
| Operation humidity | 30%-90% | |

IV. Installation

1 Control box installation

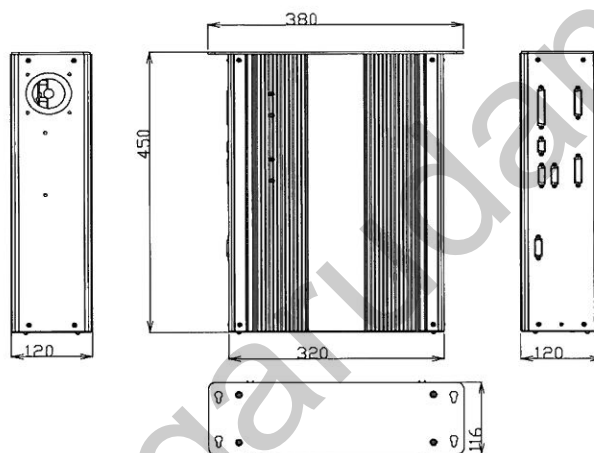

2 Pedal sensor installation

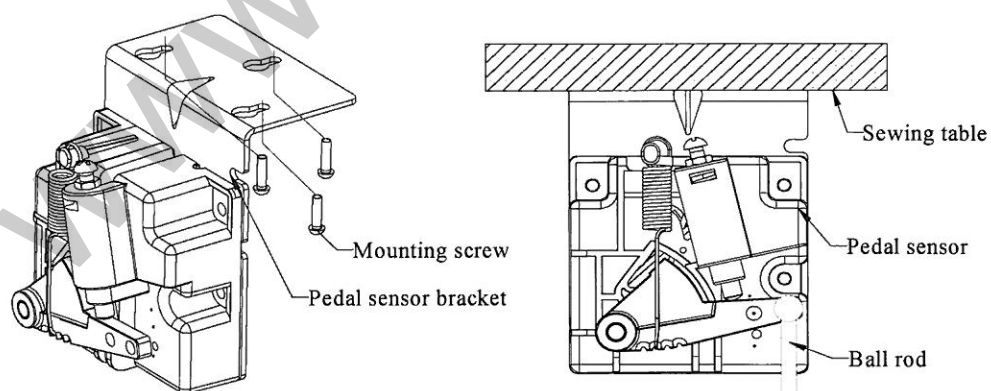

3 Diagram after installation

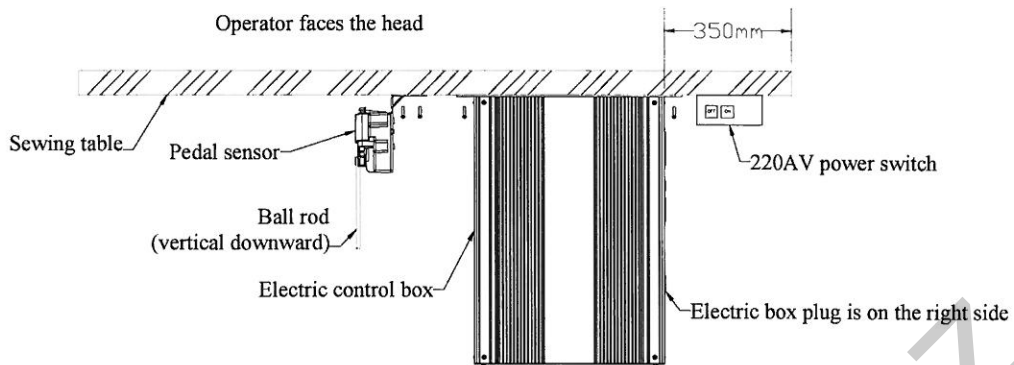

V. Operation panel operation method

1 Name and function of parts of operation panel

1.1 Operating box

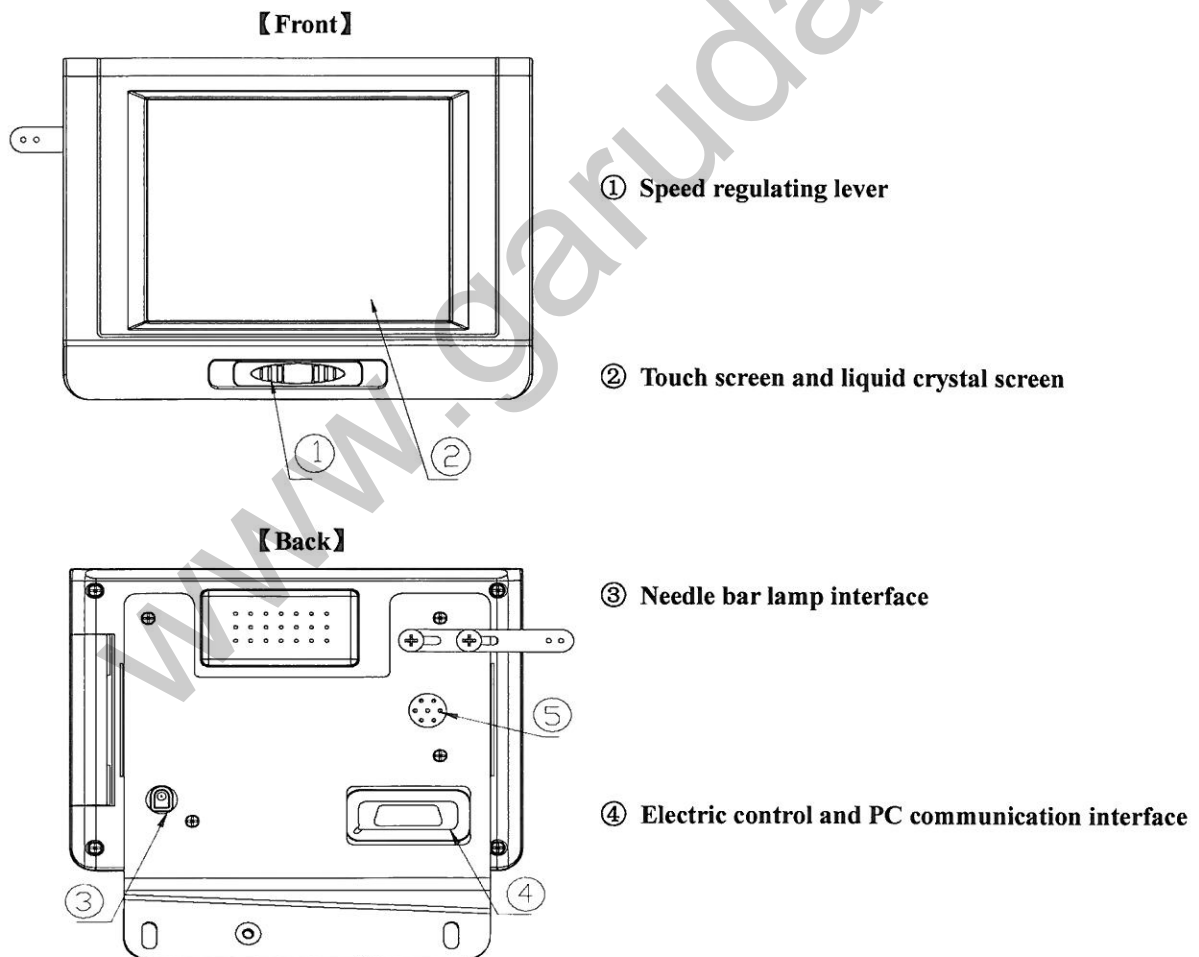

【Side】



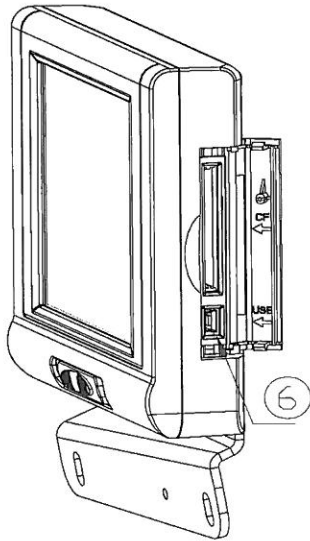





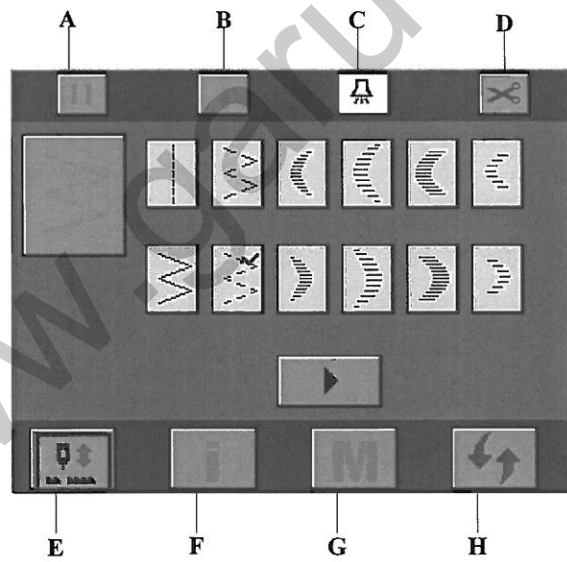











⑤ Buzzer sounding port



⑥ USB memory interface

1.2 Universal touch buttons







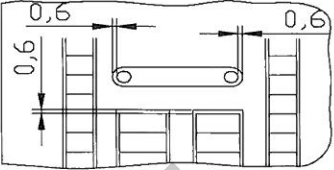

| <p>⚠ The following elements are included in all interfaces. Please read the following table carefully to get familiar with their functions.</p> | |
|--|---|
| <p>A: operation enable/disable button</p>  | <p>→ Press this button, the displayed icon will be switched between  and .</p> <p>: The machine is enabled and ready for sewing;</p> <p>: The machine is disabled and unavailable for sewing.</p> <p>⚠ In some interfaces, this button cannot be set and is only displayed as , this means the current interface is forbidden.</p> |
| <p>B: Over limit alarm button</p>  | <p>→ This icon indicates the current pattern parameter is over limit, <u>see 11.1.3</u>. In this case, Button A automatically appears as , and the machine is disabled. Please enter Pattern Attribute Setting interface to revise pattern parameter, or enter Universal Parameter Setting interface to revise the correspondent system parameter.</p> <p>See <u>System Management Setting</u> → <u>Universal Parameter Setting</u>.</p> <p>→ Click this button, Universal Parameter Interface will appear; release the button, the interface will disappear.</p> <p>See 11.1.3 <u>Data Over Limit Alarm</u>.</p> <p>→ If the pattern parameter is within limit, this alarm will not appear.</p> |
| <p>C: Needle bar lamp on/off button</p> | <p>→ Press this button to set needle bar lamp state, and the displayed icon will be switched between  and .</p> <p>: Turn on needle bar lamp;</p> <p>: Turn off needle bar lamp.</p> |
| <p>D: Trimming enable/disable button</p>  | <p>→ Press this button to set trimming, and the displayed icon will be switched between  and .</p> <p>: Enable trimming for the current pattern;</p> <p>: Disable trimming for the current pattern;</p> |
| <p>E: Half stitch compensation button</p>  | <p>→ Half stitch correcting for the functional buttons used in sewing.</p> <p>→ Half stitch/one stitch can be switched by revising P12 parameter in management mode.</p> <p>See <u>System Management Setting</u> → <u>System Parameter Setting</u>.</p> |
| <p>F: Information setting interface button</p>  | <p>→ Click this button to enter <u>System Information Setting</u> interface.</p> |
| <p>G: Management setting interface button</p>  | <p>→ Click this button to enter <u>System Management Setting</u> interface.</p> |
| <p>H: Main interface circulating switch button</p>  | <p>→ Click this button to allow the operating box to switch among the four main interfaces circularly.</p> |

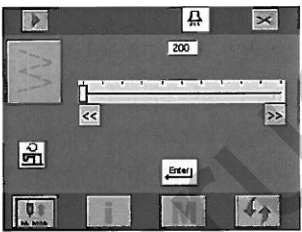
2 Before sewing

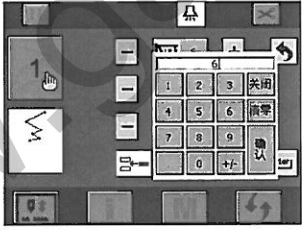
| | | |
|---|--|---|
|  Caution | <p>After replacing presser foot, needle plate or feed dog, adjust the clearance between the needle and the presser foot, needle plate and feed dog to 0.6mm or greater to prevent needle breaking and feed dog damage.</p> <p>Standard configuration upon shipment:</p> <p>II Needle maximum zigzag width is 8mm; maximum feeding volume is 5mm.</p> |  |
|---|--|---|

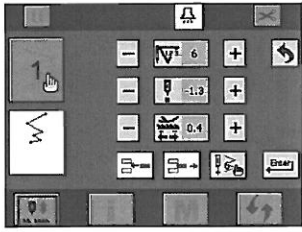

2.1 Description of three data setting modes

| Name | Graphic | Operation |
|---|---|--|
| Method 1: Slipper setting interface |  | <p>→ Drag the slipper or click “<<” and “>>” on both sides to set data. After setting, click  to save data and return to the previous interface.</p> |
| Method 2: Keypad setting interface |  | <p>→ Enter data through the embossed keypad, then click “Enter” to finish entering, and the keypad will be cancelled automatically.</p> <p>→ +/-: Plus/minus sign, press this button to switch the entered data between plus and minus; Off: Manually turn off the keypad; Clear: Clear data and reenter data.</p> |
| Method 3:  ,  key setting |  | <p>→ Use these two keys to fine adjust the relevant data.</p> |

 If Slipper Setting Interface presents in the following text, that means entering the above Slipper Setting Interface for data setting; if Keypad Setting Interface presents, that means entering the above Keypad Setting Interface for data setting.

2.2 Setting needle max. zigzag width

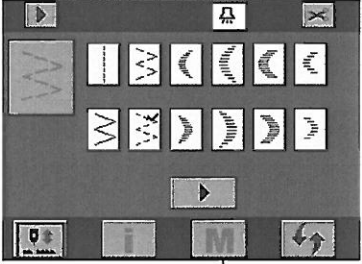
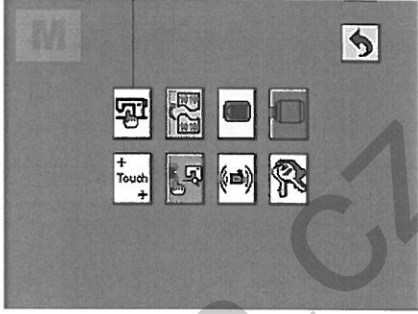
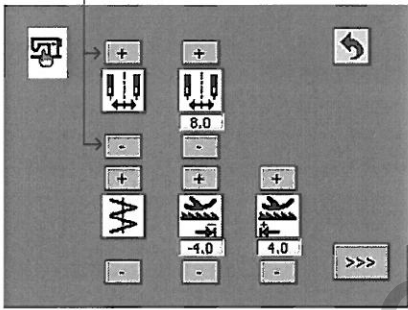
 Follow the following procedure for setting.

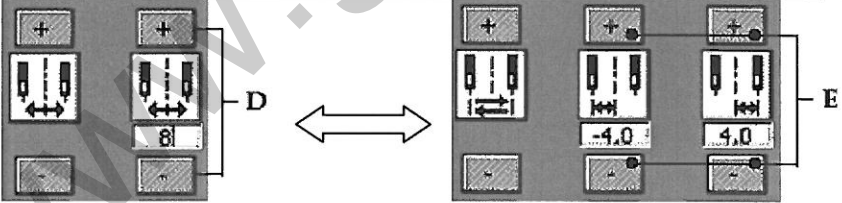
| | |
|---|--|
|  <p>1) Click Button A</p> |  <p>2) Click Button B</p> |
|  <p>3) Click Button C</p> | <p> When you click Button C, the following two setting items will appear,</p> <p>The left figure: Central symmetric zigzag width; The right figure: Specified left/right positions</p> |
|  | |
| <p>For central symmetric positions:</p> <p>Click +/- key of Button D to set limit value (8 in this example)</p> | <p>For specified left/right positions:</p> <p>Click +/- key of Button E to set left/right limit value (in this example: Left limit value is -4.0, right limit value is 4.0)</p> |

2.3 Setting reference line position

 The reference position of the reference line can be set at left, right and center

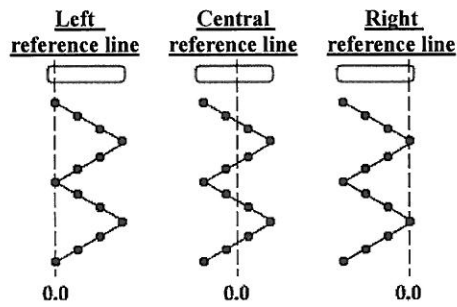

1) Click Button A

2) Click Button B

3) Click Button C

⚠ When you click Button C, the following three setting items will appear, please make settings as required.

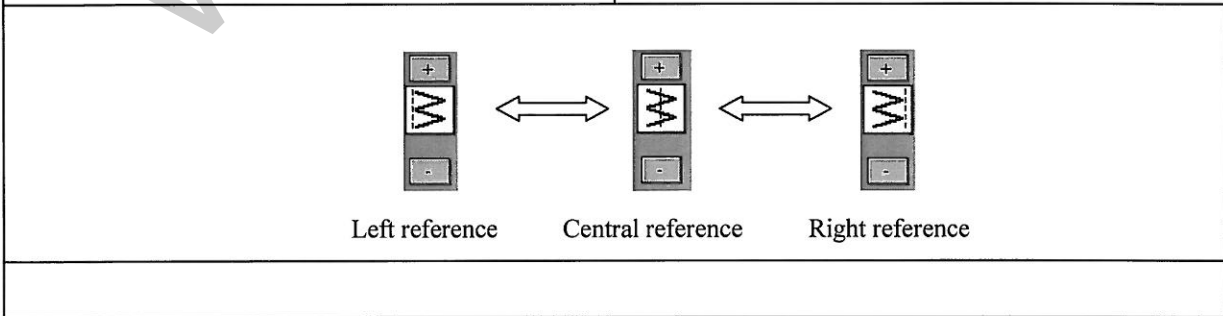

2.4 Setting feeding volume limit

👉 Follow the following procedure for setting.

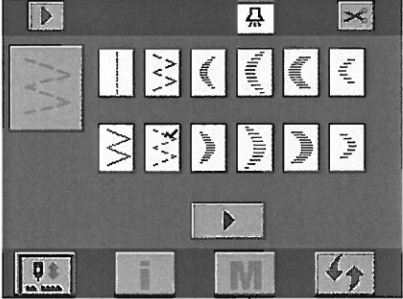
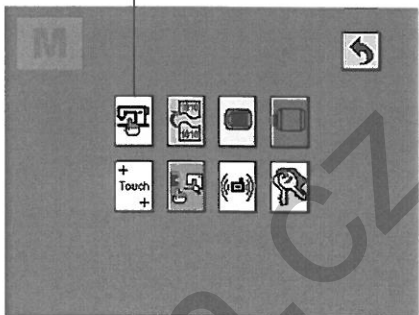
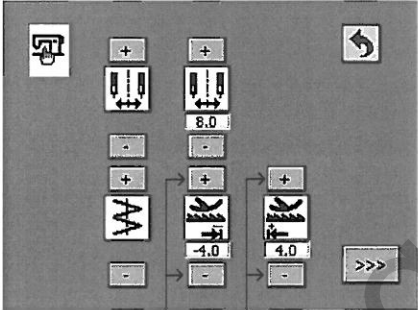
| | |
|---|--|
|  <p>1) Click Button A</p> |  <p>2) Click Button B</p> |
|  <p>3) Click Button C</p> | <p>⚠️ Click +/- of Button C to set the feeding volume limit in reverse direction (-4.0 in this example); Click +/- of Button D to set the feeding volume limit in forward direction (4.0 in this example).</p> |

3 Main interface description

👉 When the power is turned on, the last screen before power off will be displayed on the operating box.

👉 Continuously click , the screen will in the following sequence, taking 4-point zigzag as an example.

⚠️ The displayed contents may vary with the specific setting.

Pattern selection interface:

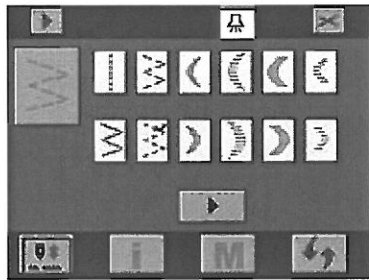

Pattern attribute interface:

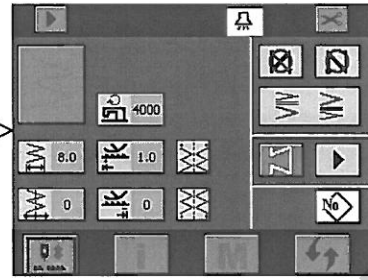

Sewing mode interface:

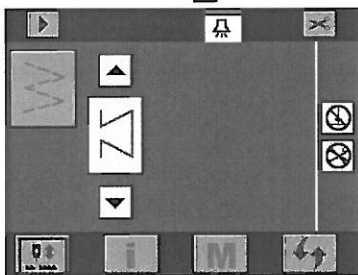

Bar-tacking mode interface:

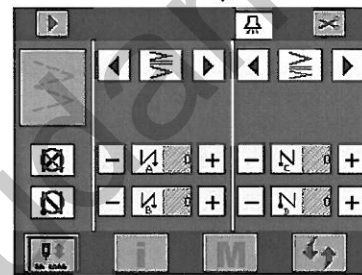

| | |
|--------------------|---|
| Caution | After changing pattern or zigzag width, check that the needle, presser foot, needle plate and feed dog are adaptable to the current operating condition, otherwise, needle breaking or feed dog damage may occur. |
|--------------------|---|







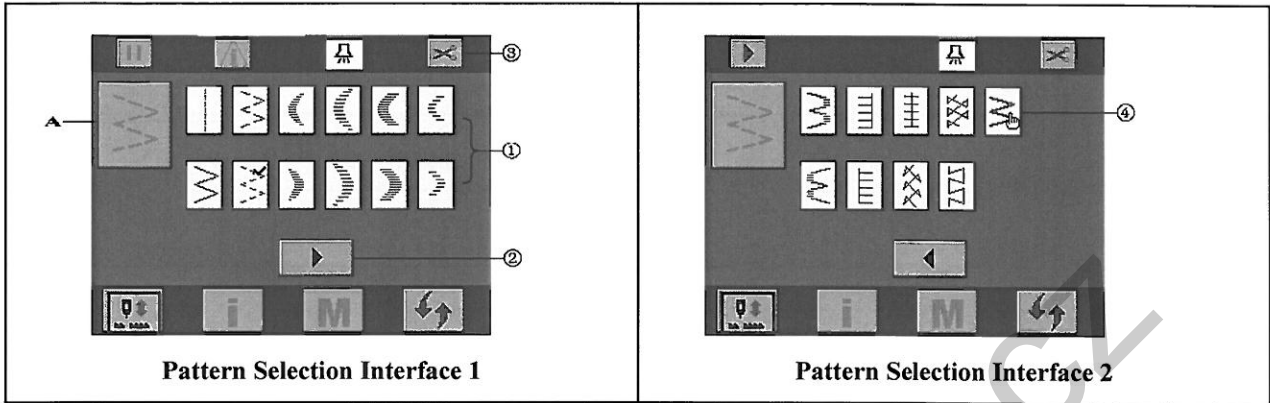

4 Pattern selection

- Pattern selection function: Select a pattern for sewing
- Click to switch to pattern selection interface.
- Click a pattern in ① Pattern Selection Field, the selected pattern will be marked with ✓ on the top right corner.





















4.1 Standard pattern selection

There are 20 standard patterns available.



| | |
|--|--|
| <p>⚠ Please read the following table to get familiar with the interface elements and their functions.</p> | |
| <p>A: Current pattern</p>  | <p>→ Mark of current pattern, indicating the selected pattern.</p> <p>→ Click it to enter Pattern Attribute Setting interface.</p> |
| <p>⚠ Please select patterns in the following steps.</p> | |
| <p>①: Pattern selection field</p> | <p>→ Click this field to select desired sewing pattern.</p> <p>See “Standard Pattern Table” in this section.</p> |
| <p>②: Page turning button</p>  | <p>→ Click it to enter Pattern Selection Page 2.</p> |
| <p>③: Trimming enable/disable button</p>  | <p>→ Press this button to set trimming, and the displayed icon will be switched between  and .</p> <p>: Enable trimming for the current pattern;</p> <p>: Disable trimming for the current pattern;</p> |
| <p>④: Customized pattern</p>  | <p>→ Customized pattern icon, click it to enter Customized pattern Selection interface.</p> <p>See “Customized pattern selection” in this section.</p> |

 Standard Pattern Table

| Pattern Name | Graphic | Pattern Name | Graphic |
|-------------------------------|---|-------------------------------|---|
| Straight stitch |  | Left 12-stitch equal scallop |  |
| 2-point zigzag |  | Right 12-stitch equal scallop |  |
| 3-point zigzag |  | Left blind stitch |  |
| 4-point zigzag |  | Right blind stitch |  |
| Left standard scallop |  | Left T shape* |  |
| Right standard scallop |  | Right T shape* |  |
| Left crescent scallop |  | Pattern 1* |  |
| Right crescent scallop |  | Pattern 2* |  |
| Left 24-stitch equal scallop |  | Pattern 3* |  |
| Right 24-stitch equal scallop |  | Pattern 4* |  |

Note: Patterns marked with * in the above table are only available for 2290S-SR.

4.2 Customized pattern selection

Total 20 patterns can be customized.

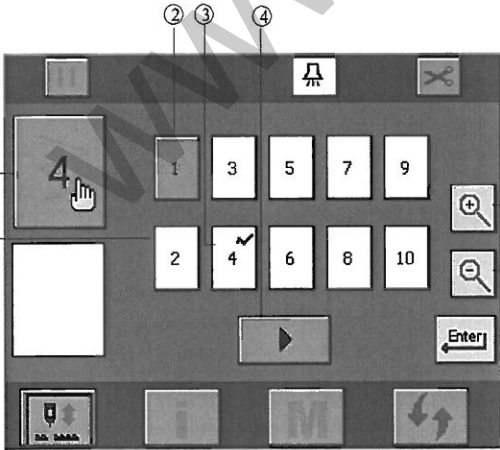

A: Display the current selected customization number;

B: Zoom in the display field graphic;

C: Zoom out the display field graphic;

①: Customization number without pattern;



②: Customization number with pattern;

③: Selected customization number,

Green: with pattern; white: without pattern;

④: Page turning button;



⑤: Enter, to confirm the current operation.









- 1) Select a null number (white), press  to enter **Customized Start Point Setting** interface to set the specific start point.
- 2) Select a non-null number (green), press  to enter **Pattern Attribute Setting → Customized Pattern Setting** interface to set the attribute of the customized pattern.

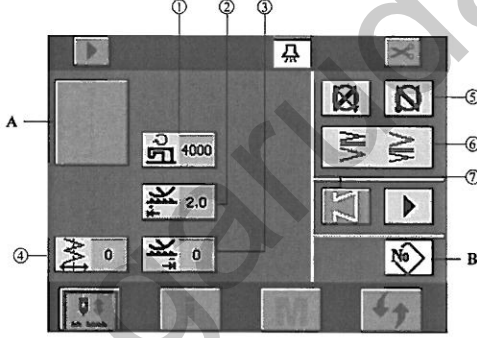















5 Pattern attribute setting

-  Pattern attribute setting function: Set the maximum zigzag, reference line and maximum speed for the pattern.

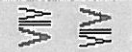
5.1 Straight stitch setting



-  After selecting straight stitch  in **Pattern Selection** interface, click the main interface circulating switch button  to enter Pattern Attribute Setting interface and set the attribute of straight stitch.

| | |
|---|--|
|  | |
| <p> The displayed contents depend on the specific setting.</p> <p> Please read the following table to get familiar with the interface elements and their functions.</p> | |
| <p>A: Current pattern</p>  | <p>→ Display the current pattern</p> |
| <p> Please set pattern attribute in the following steps.</p> | |
| <p>①: Maximum speed setting button</p>  | <p>→ Click this button to enter Slipper Setting Interface for speed setting.</p> |
| <p>②: Forward feeding volume button</p>  | <p>→ Click this button to enter Slipper Setting Interface for forward feeding volume setting.</p> |
| <p>③: Reverse feeding volume setting button</p>  | <p>→ Click this button to enter Slipper Setting Interface for reverse feeding volume setting.</p> |

| | |
|--|---|
| <p>④: Reference line setting button</p>  | <p>→ The displayed icon depends on reference line setting in Sewing Universal Information. Including: Left reference: ; central reference: ; right reference: ; → Click this button to enter Slipper Setting Interface for reference line setting.</p> |
| <p>⑤: Front/back bar-tacking enable button</p>  | <p>→ Click  to switch between  and , i.e. disable or enable front bar-tacking. → Click  to switch between  and , i.e. disable or enable back bar-tacking.</p> |
| <p>⑥: Type of front/back bar-tacking</p>  | <p>→ Display the bar-tacking type of the current pattern; → click this button to enter Bar-tacking Setting interface to set the bar-tacking type for the current pattern.</p> |
| <p>⑦: Mode display button</p>  | <p>→ Display current sewing mode; click this button to enter Sewing Mode Setting interface. → Click  on the right side to circularly switch among ,  and  modes.</p> |

 **Caution** The actual sewing speed will be restricted by the settings of pattern, zigzag width, feeding volume and maximum speed (P04) etc; the program will integrate the setting restrictions to select the optimum sewing speed.

5.2 2-point, 3-point and 4-point zigzag stitch setting

 After selecting 4-point zigzag  in **Pattern Selection** interface, click the main interface circulating switch button  to enter Pattern Attribute Setting interface and set the attribute of zigzag stitch. (Take 4-point zigzag as an example.)

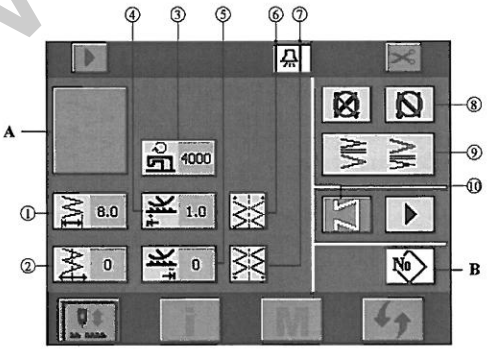











⚠ The displayed contents depend on the specific setting.



⚠ Please read the following table to get familiar with the interface elements and their functions.

| | |
|-------|---|
| A, B: | → Same as A and B of straight stitch attribute setting. |
|-------|---|

⚠ Please set pattern attribute in the following steps.

| | |
|---|---|
| ①: Zigzag width setting button  | → Click this button to enter Slipper Setting Interface for zigzag width setting. . |
| ②: Reference line setting button  | → The icon varies with the reference line setting in Sewing Universal Information. Including: Left reference:  ; central reference:  ; right reference:  . → Click this button to enter Slipper Setting Interface for reference line setting. |
| ③: Maximum speed setting button  | → Click this button to enter Slipper Setting Interface for speed setting. . |
| ④: Forward feeding volume button  | → Click this button to enter Slipper Setting Interface for forward feeding volume setting. |
| ⑤: Reverse feeding volume button  | → Click this button to enter Slipper Setting Interface for reverse feeding volume setting. |
| ⑥: Start point setting button  | → Click this button to enter Start Point Setting Interface for start point setting. See “Start point setting interface” in this section. |
| ⑦: End point setting button  | → Click this button to enter End Point Setting Interface for end point setting. See “end point setting interface” in this section. |
| ⑧⑨⑩: | → Same as ③④⑤ in straight stitch setting. |

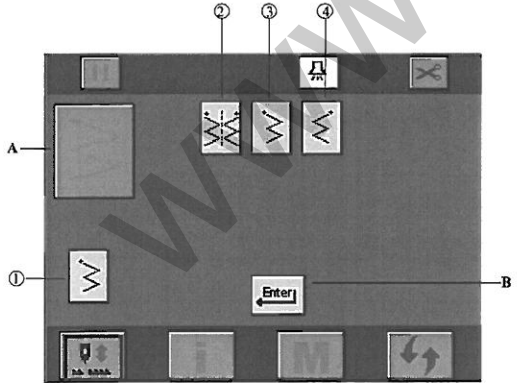
 Start point setting interface

| | |
|---|---|
|  <p>The diagram shows a control panel with several buttons. A large rectangular area is labeled 'A'. To its right are three buttons labeled ①, ②, and ③. Further right are two buttons labeled ④ and ⑤. Below these is an 'Enter' button. At the bottom left is a button with a downward arrow, and at the bottom right is a button with a circular arrow. A label 'B' points to the 'Enter' button.</p> | <p>A: Current pattern; B: Enter, to return to the previous interface;</p> <p>①: Current start point setting; ②: start point at any position; ③: Start point on the left; ④: Start point on the right.</p> <p> The displayed contents depend on the specific setting.</p> |
|---|---|

End point setting interface

| | |
|--|--|
| | <p>A: Current pattern; B: Enter, to return to the previous interface;</p> <p>①: Current end point setting; ②: End point at any position; ③: End point on the left; ④: End point on the right.</p> <p> The displayed contents depend on the specific setting.</p> |
|--|--|

5.3 Scallop setting

After selecting left crescent in **Pattern Selection** interface, click the main interface circulating switch button to enter Pattern Attribute Setting interface and set the attribute of left crescent. (Take left crescent as an example.)





| | |
|--|--|
| <p>A</p> <p>①</p> <p>②</p> | |
| <p> The displayed contents may vary with the specific setting.</p> | |

Please read the following table to get familiar with the interface elements and their functions.



A, B: → Same as A and B of straight stitch attribute setting.

Please set pattern attribute in the following steps.

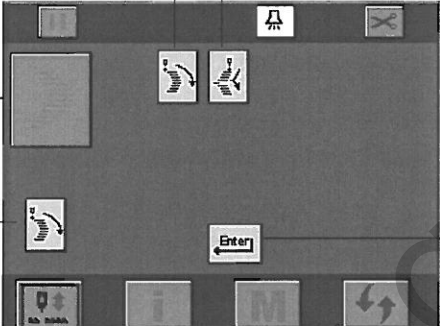

| | |
|---|--|
| <p>①: Zigzag width setting button</p> | <p>→ Click this button to enter Slipper Setting Interface for zigzag width setting. .</p> |
| <p>②: Reference line setting button</p> | <p>→ The icon varies with the reference line setting in Sewing Universal Information. Including: Left reference: ; central reference: ; right reference: .</p> <p>→ Click this button to enter Slipper Setting Interface for reference line setting.</p> |

| | |
|---|--|
| ③: Maximum speed setting button  | → Click this button to enter Slipper Setting Interface for speed setting. . |
| ④: Forward feeding volume button  | → Click this button to enter Slipper Setting Interface for forward feeding volume setting. |
| ⑤: Reverse feeding volume button  | → Click this button to enter Slipper Setting Interface for reverse feeding volume setting. |
| ⑥: Start point setting button  | → Click this button to enter Start Point Setting Interface for start point setting. See “Start point setting interface” in this section. |
| ⑦: End point setting button  | → Click this button to enter End Point Setting Interface for end point setting. See “end point setting interface” in this section. |
| ⑧⑨⑩: | → Same as ③④⑤ in straight stitch setting. |

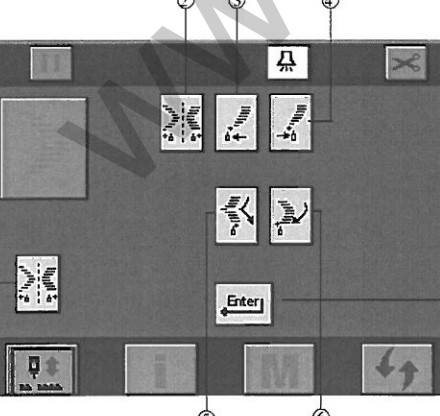

 Start point setting interface

| | |
|---|--|
|  <p>The screenshot shows a control panel with a large display area labeled 'A' on the left. Below the display is a button labeled '1'. To the right of the display are two buttons labeled '2' and '3'. At the bottom center is an 'Enter' button labeled 'B'. The bottom of the panel has several other buttons and a directional pad.</p> | <p>A: Current pattern; B: Enter, to return to the previous interface;</p> <p>①: Current start point setting; ②: Start point at valley position; ③: Start point at peak position.</p> <p> The displayed contents depend on the specific setting.</p> |
|---|--|

 End point setting interface

| | |
|---|---|
|  <p>The screenshot shows a control panel with a large display area labeled 'A' on the left. Below the display is a button labeled '1'. To the right of the display are three buttons labeled '2', '3', and '4'. At the bottom center is an 'Enter' button labeled 'B'. Below the display are two buttons labeled '5' and '6'. The bottom of the panel has several other buttons and a directional pad.</p> | <p>A: Current pattern; B: Enter, to return to the previous interface;</p> <p>①: Current end point mark; → End point left/right setting; ②: End point on the left; ③: End point on the right; → End point peak/valley setting; ④: End point at any position; ⑤: End point at peak; ⑥: End point at valley.</p> <p> The displayed contents depend on the specific setting.</p> |
|---|---|





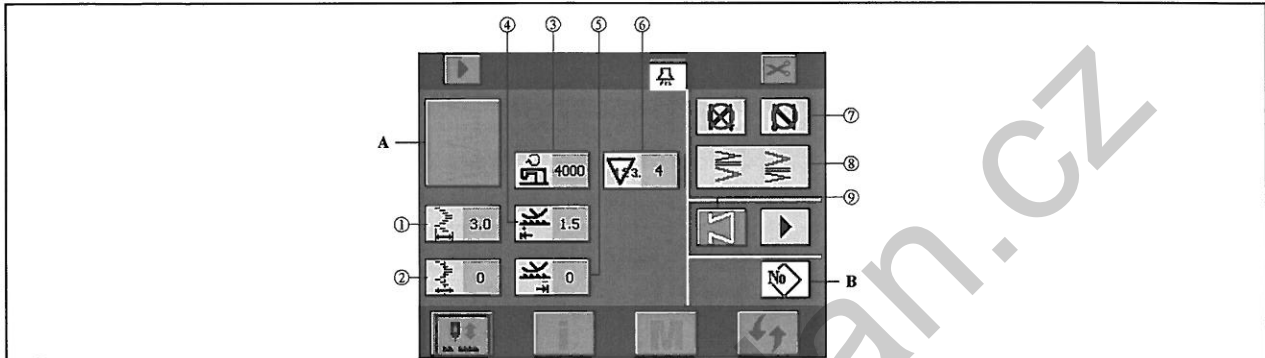



5.4 Blind stitch setting

- ☞ After selecting left blind stitch  in **Pattern Selection** interface, click the main interface circulating switch button  to enter **Pattern Attribute Setting** interface and set the attribute of left blind stitch. (Take left blind stitch as an example.)

















⚠ The displayed contents depend on the specific setting.

⚠ Please read the following table to get familiar with the interface elements and their functions.



| | |
|---|---|
| A, B: | → Same as A and B of straight stitch attribute setting. |
| ⚠ Please set pattern attribute in the following steps. | |
| ①: Zigzag width setting button  | → Click this button to enter Slipper Setting Interface for zigzag width setting. . |
| ②: Reference line setting button  | → The icon varies with the reference line setting in Sewing Universal Information. Including: Left reference:  ; central reference:  ; right reference:  . → Click this button to enter Slipper Setting Interface for reference line setting. |
| ③: Maximum speed setting button  | → Click this button to enter Slipper Setting Interface for speed setting. . |
| ④: Forward feeding volume button  | → Click this button to enter Slipper Setting Interface for forward feeding volume setting. |
| ⑤: Reverse feeding volume button  | → Click this button to enter Slipper Setting Interface for reverse feeding volume setting. |
| ⑥ : Blind stitch number point setting button  | → Click this button to enter Slipper Setting Interface for stitch number setting. . |
| ⑦⑧⑨: | → Same as ③④⑤ in straight stitch setting. |

5.5 T shape setting

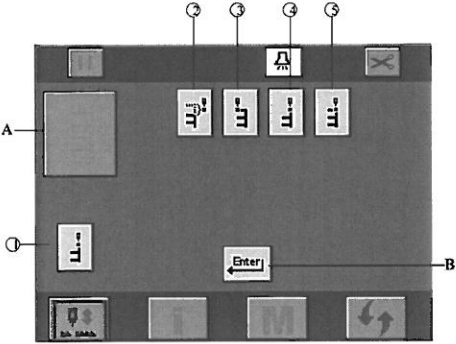

- After selecting left T shape  in **Pattern Selection** interface, click the main interface circulating switch button  to enter **Pattern Attribute Setting** interface and set the attribute of left T shape. (Take left T shape as an example.)

| | |
|---|---|
| | |
| <p> The displayed contents depend on the specific setting.</p> | |
| <p> Please read the following table to get familiar with the interface elements and their functions.</p> | |
| A, B: | → Same as A and B of straight stitch attribute setting. |
| <p> Please set pattern attribute in the following steps.</p> | |
| ①: Zigzag width setting button  | → Click this button to enter Slipper Setting Interface for zigzag width setting. . |
| ②: Reference line setting button  | → The icon varies with the reference line setting in Sewing Universal Information. Including: Left reference:  ; central reference:  ; right reference:  → Click this button to enter Slipper Setting Interface for reference line setting. |
| ③: Maximum speed setting button  | → Click this button to enter Slipper Setting Interface for speed setting. |
| ④: Forward feeding volume button  | → Click this button to enter Slipper Setting Interface for forward feeding volume setting. |
| ⑤: Corrected value setting button  | → Click this button to enter Slipper Setting Interface for corrected value setting. |
| ⑥: Start point setting button  | → Click this button to enter Start Point Setting Interface for start point setting. See “Start point setting interface” in this section. |
| ⑦: End point setting button  | → Click this button to enter End Point Setting Interface for end point setting. See “end point setting interface” in this section. |
| ⑧⑨⑩: | → Same as ③④⑤ in straight stitch setting. |

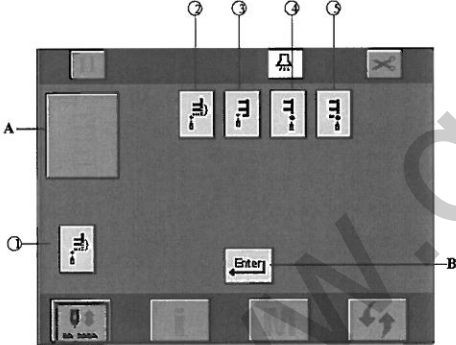

 Start point setting interface

| | |
|---|---|
|  | <p>A: Current pattern; B: Enter, to return to the previous interface;</p> <p>①: Current start point mark; ②: start point at any position; ③: Start point on the left; ④: Start point on right 1; ⑤: Start point on right 2.</p> <p> The displayed contents depend on the specific setting.</p> |
|---|---|

 End point setting interface

| | |
|---|---|
|  | <p>A: Current pattern; B: Enter, to return to the previous interface;</p> <p>①: Current end point mark; ②: End point at any position; ③: End point on the left; ④: End point on right 1; ⑤: End point on right 2.</p> <p> The displayed contents depend on the specific setting.</p> |
|---|---|

5.6 Pattern 1 setting

 After selecting pattern 1  in **Pattern Selection** interface, click the main interface circulating switch button  to enter Pattern Attribute Setting interface and set the attribute of pattern 1.

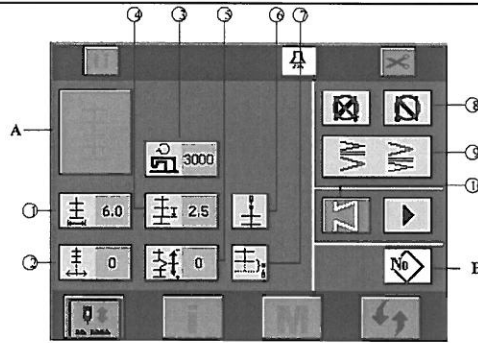

⚠ The displayed contents depend on the specific setting.

⚠ Please read the following table to get familiar with the interface elements and their functions.

A, B: → Same as A and B of straight stitch attribute setting.

⚠ Please set pattern attribute in the following steps.

①: Zigzag width setting button



→ Click this button to enter **Slipper Setting Interface** for zigzag width setting. .

②: Reference line setting button



→ The icon varies with the reference line setting in Sewing Universal Information. Including:

Left reference: ; central reference: ; right reference: .

→ Click this button to enter **Slipper Setting Interface** for reference line setting.

③: Maximum speed setting button



→ Click this button to enter **Slipper Setting Interface** for speed setting. .

④: Forward feeding volume button



→ Click this button to enter **Slipper Setting Interface** for forward feeding volume setting.

⑤: Corrected value setting button



→ Click this button to enter **Slipper Setting Interface** for corrected value setting.

⑥: Start point setting button



→ Click this button to enter Start Point Setting Interface for start point setting. See “Start point setting interface” in this section.

⑦: End point setting button





→ Click this button to enter End Point Setting Interface for end point setting. See “end point setting interface” in this section.

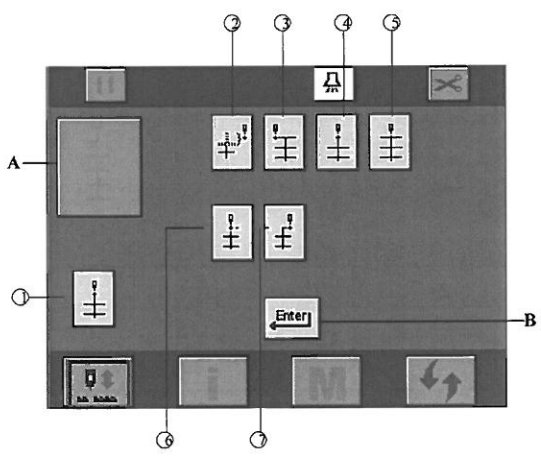

⑧⑨⑩:

→ Same as ③④⑤ in **straight** stitch setting.

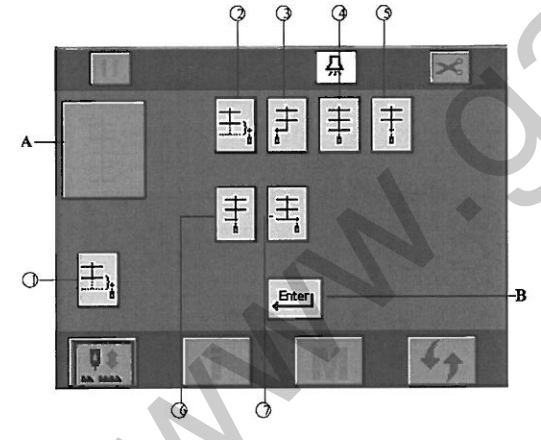

 Start point setting interface

| | |
|---|--|
|  | <p>A: Current pattern;</p> <p>B: Enter, to return to the previous interface;</p> <p>①: Current start point mark;</p> <p>②: start point at any position;</p> <p>③: Start point on the left;</p> <p>④: start point at center position 1;</p> <p>⑤: start point at center position 2;</p> <p>⑥: start point at center position 3;</p> <p>⑦: Start point on the right.</p> <p> The displayed contents depend on the specific setting.</p> |
|---|--|

 End point setting interface

| | |
|---|--|
|  | <p>A: Current pattern;</p> <p>B: Enter, to return to the previous interface;</p> <p>①: Current end point mark;</p> <p>②: End point at any position;</p> <p>③: End point on the left;</p> <p>④: end point at center position 1;</p> <p>⑤: end point at center position 2;</p> <p>⑥: end point at center position 3;</p> <p>⑦: end point on the right.</p> <p> The displayed contents depend on the specific setting.</p> |
|---|--|

5.7 Pattern 2 setting

 After selecting pattern 2  in **Pattern Selection** interface, click the main interface circulating switch button  to enter Pattern Attribute Setting interface and set the attribute of pattern 2.

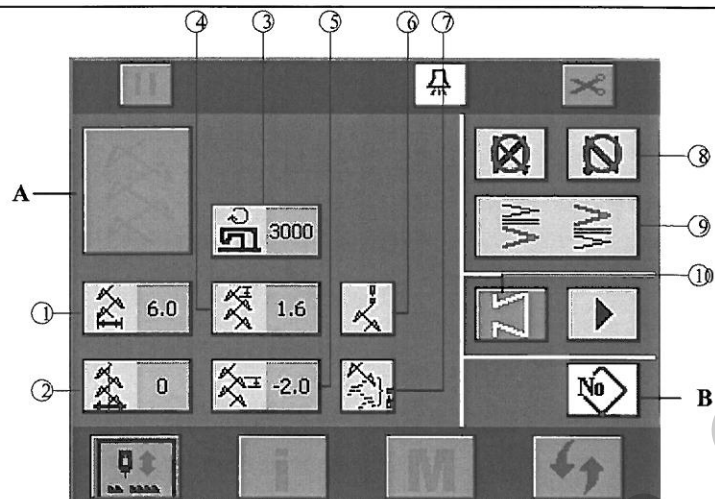









⚠ The displayed contents depend on the specific setting.

⚠ Please read the following table to get familiar with the interface elements and their functions.

A, B: → Same as A and B of straight stitch attribute setting.

⚠ Please set pattern attribute in the following steps.

| | |
|---|--|
| ①: Zigzag width setting button  | → Click this button to enter Slipper Setting Interface for zigzag width setting. . |
| ②: Reference line setting button  | → Click this button to enter Slipper Setting Interface for reference line setting. |
| ③: Maximum speed setting button  | → Click this button to enter Slipper Setting Interface for speed setting. . |
| ④: Forward feeding volume button  | → Click this button to enter Slipper Setting Interface for forward feeding volume setting. |
| ⑤: Reverse feeding volume button  | → Click this button to enter Slipper Setting Interface for reverse feeding volume setting. |
| ⑥: Start point setting button  | → Click this button to enter Start Point Setting Interface for start point setting. See “Start point setting interface” in this section. |
| ⑦: End point setting button  | → Click this button to enter End Point Setting Interface for end point setting. See “end point setting interface” in this section. |
| ⑧⑨⑩: | → Same as ③④⑤ in straight stitch setting. |



 Start point setting interface

| | |
|--|---|
| | <p>A: Current pattern; B: Enter, to return to the previous interface;</p> <p>①: Current start point mark; ②: start point at any position; ③: Start point on left 1; ④: Start point on left 2; ⑤: start point at center position 1; ⑥: start point at center position 2; ⑦: Start point on right 1; ⑧: Start point on right 2.</p> <p> The displayed contents depend on the specific setting.</p> |
|--|---|

 End point setting interface

| | |
|--|---|
| | <p>A: Current pattern; B: Enter, to return to the previous interface;</p> <p>①: Current end point mark; ②: End point at any position; ③: End point on left 1; ④: end point on left 2; ⑤: end point at center position 1; ⑥: end point at center position 2; ⑦: end point on right 1; ⑧: End point on right 2.</p> <p> The displayed contents depend on the specific setting.</p> |
|--|---|

5.8 Pattern 3 setting

- After selecting pattern 3  in **Pattern Selection** interface, click the main interface circulating switch button  to enter Pattern Attribute Setting interface and set the attribute of pattern 3.

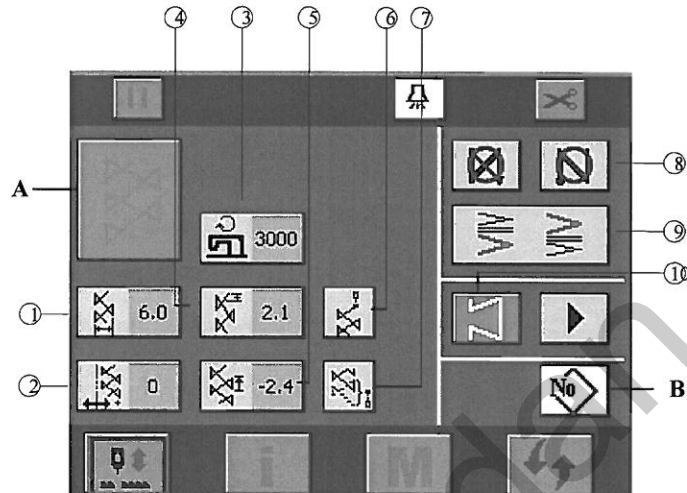









 The displayed contents depend on the specific setting.

 Please read the following table to get familiar with the interface elements and their functions.

A, B: → Same as A and B of straight stitch attribute setting.

 Please set pattern attribute in the following steps.

| | |
|---|--|
| ①: Zigzag width setting button  | → Click this button to enter Slipper Setting Interface for zigzag width setting. . |
| ②: Reference line setting button  | → Click this button to enter Slipper Setting Interface for reference line setting. |
| ③: Maximum speed setting button  | → Click this button to enter Slipper Setting Interface for speed setting. . |
| ④: Forward feeding volume button  | → Click this button to enter Slipper Setting Interface for forward feeding volume setting. |
| ⑤: Reverse feeding volume button  | → Click this button to enter Slipper Setting Interface for reverse feeding volume setting. |
| ⑥: Start point setting button  | → Click this button to enter Start Point Setting Interface for start point setting. See “Start point setting interface” in this section. |
| ⑦: End point setting button  | → Click this button to enter End Point Setting Interface for end point setting. See “end point setting interface” in this section. |
| ⑧⑨⑩: | → Same as ③④⑤ in straight stitch setting. |



 Start point setting interface

| | |
|--|--|
| | <p>A: Current pattern; B: Enter, to return to the previous interface;</p> <p>①: Current start point mark; ②: Start point at any position; ③: START point on left 1; ④: Start point on left 2; ⑤: Start point at center position 1; ⑥: Start point at center position 2; ⑦: Start point on right 1; ⑧: Start point on right 2;</p> <p> The displayed contents depend on the specific setting.</p> |
|--|--|

 End point setting interface

| | |
|--|---|
| | <p>A: Current pattern; B: Enter, to return to the previous interface;</p> <p>①: Current end point mark; ②: End point at any position; ③: End point on left 1; ④: End point on left 2; ⑤: End point at center position 1; ⑥: End point at center position 2; ⑦: End point on right 1; ⑧: End point on right 2;</p> <p> The displayed contents depend on the specific setting.</p> |
|--|---|

5.9 Pattern 4 setting

- ➡ After selecting pattern 4  in **Pattern Selection** interface, click the main interface circulating switch button  to enter **Pattern Attribute Setting** interface and set the attribute of pattern 4.

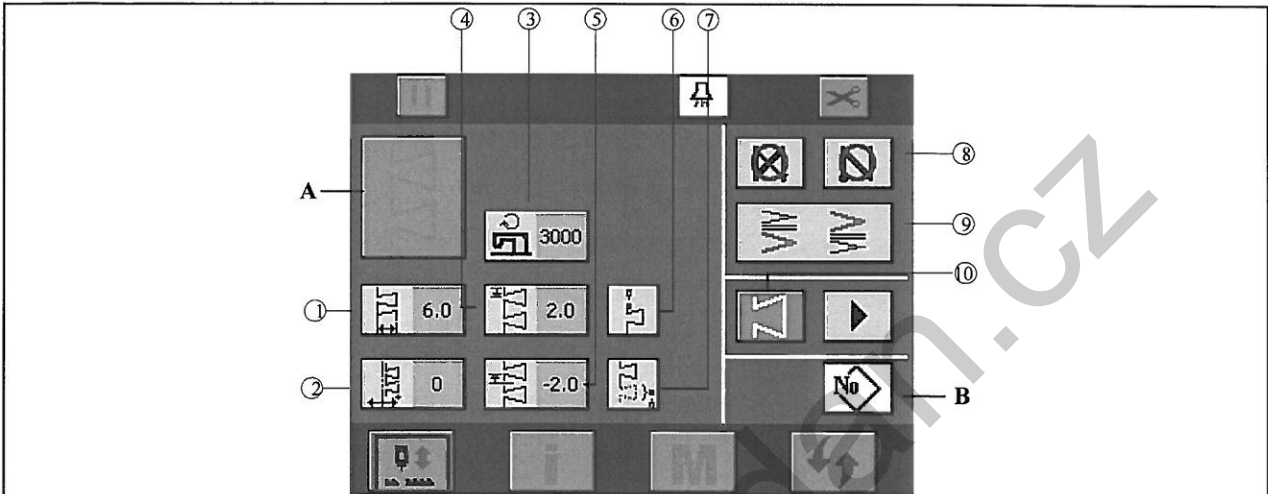









⚠ The displayed contents depend on the specific setting.



⚠ Please read the following table to get familiar with the interface elements and their functions.

A, B: → Same as A and B of straight stitch attribute setting.

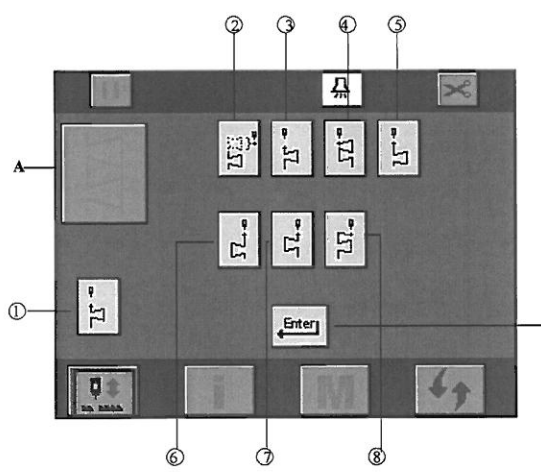

⚠ Please set pattern attribute in the following steps.

| | |
|---|---|
| ①: Zigzag width setting button  | → Click this button to enter Slipper Setting Interface for zigzag width setting. . |
| ②: Reference line setting button  | → Click this button to enter Slipper Setting Interface for reference line setting. |
| ③: Maximum speed setting button  | → Click this button to enter Slipper Setting Interface for speed setting. . |
| ④: Forward feeding volume button  | → Click this button to enter Slipper Setting Interface for forward feeding volume setting. |
| ⑤: Reverse feeding volume button  | → Click this button to enter Slipper Setting Interface for reverse feeding volume setting. |
| ⑥: Start point setting button  | → Click this button to enter Start Point Setting Interface for start point setting. See “Start point setting interface” in this section. |
| ⑦: End point setting button  | → Click this button to enter End Point Setting Interface for end point setting. See “end point setting interface” in this section. |
| ⑧⑨⑩: | → Same as ③④⑤ in straight stitch setting. |

 Start point setting interface

| | |
|---|---|
|  | <p>A: Current pattern; B: Enter, to return to the previous interface;</p> <p>①: Current start point mark; ②: start point at any position; ③: Start point on left 1; ④: Start point on left 2; ⑤: Start point on left 3; ⑥: Start point on right 1; ⑦: Start point on right 2; ⑧: Start point on right 3.</p> <p> The displayed contents depend on the specific setting.</p> |
|---|---|

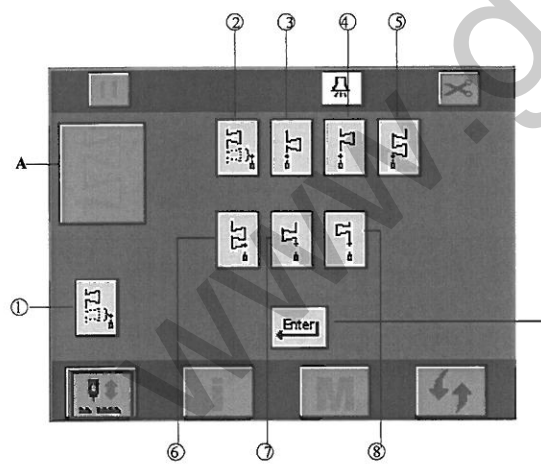
 End point setting interface

| | |
|---|--|
|  | <p>A: Current pattern; B: Enter, to return to the previous interface;</p> <p>①: Current end point mark; ②: End point at any position; ③: End point on left 1; ④: end point on left 2; ⑤: End point on left 3; ⑥: end point on right 1; ⑦: end point on right 2; ⑧: end point on right3 .</p> <p> The displayed contents depend on the specific setting.</p> |
|---|--|



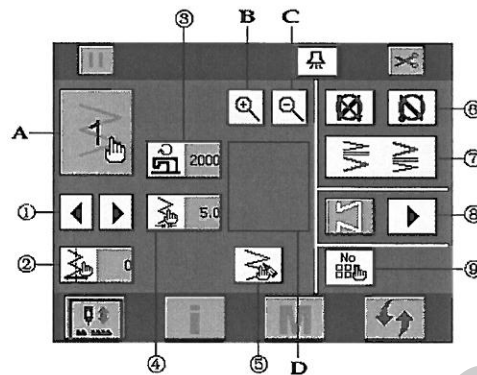

5.10 Customized pattern setting

- ➡ After selecting customized pattern  in **Pattern Selection** interface, enter customized pattern selection interface to select and confirm customized pattern, then enter pattern attribute setting interface to set the attribute of the customized pattern.

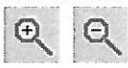

⚠ The displayed contents depend on the specific setting.

⚠ Please read the following table to get familiar with the interface elements and their functions.

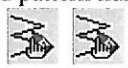

| | |
|---|--|
| A: Current customized pattern number  | → Display the current pattern number, in the range of 1-20. |
| B, C: Pattern zoom button  | → Zoom in/out the customized pattern. When the pattern is too large for the display field, adjust the zoom button to display it completely in the display field. |
| D: Pattern display field | → This field is designed to display the shape of the pattern. |
| ⚠ Please set pattern attribute in the following steps. | |
| ①: Customized pattern number selection  | → Click this button to allow the pattern number of ② to switch among the customized pattern numbers with pattern. For example, if there are pattern data in customized numbers 1, 2 and 5, click this button, the pattern number of ② will be displayed as: 1->2->5->.... |
| ②: Reference line setting button  | → Click this button to enter Slipper Setting Interface for reference line setting. |
| ③: Maximum speed setting button  | → Click this button to enter Slipper Setting Interface for speed setting. . |
| ④: Zigzag width setting button  | → Click this button to enter Slipper Setting Interface for zigzag width setting. |
| ⑤: Customized pattern number edit button  | → Click this button to enter Customized Start Point Setting Interface for pattern start point setting. See “ Customized start point setting ”. |

| | |
|--|---|
| ⑨: Pattern operation button  | → Click this button to enter Customization Copy and Delete Interface. See “ Customization copy and delete ”. |
| ⑥⑦⑧ | → Same as ③④⑤ in straight stitch setting. |

6 Bar-tacking setting

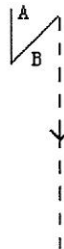

Bar-tacking concept

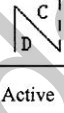
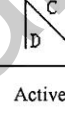
| Front bar-tacking | Inactive | Active | Inactive | Active |
|-------------------|---|---|--|--|
| Sewing pattern |  |  |  |  |
| | | |  |  |
| Back bar-tacking | Inactive | Inactive | Active | Active |

Bar-tacking purpose: For reinforcement at the beginning and/or end of sewing.

Bar-tacking types: Standard bar-tacking, 2-point shirring and customized bar-tacking.

Each pattern can be set with its own bar-tacking type separately.

Two settings of bar-tacking

- For straight stitch, scallop, blind stitch and customized pattern (setting unit of A, B, C and D is stitch number),
 - Front bar-tacking → A (forward feeding): 0-19 stitches.
B (reverse feeding): 0-19 stitches.
 - Back bar-tacking → C (back feeding): 0-19 stitches.
D (forward feeding): 0-19 stitches.
- For 2-point zigzag, 3-point zigzag and 4-point zigzag (setting unit of A, B, C and D is zigzag round times),
 - Front bar-tacking → A (forward feeding): 0-19 rounds.
B (reverse feeding): 0-19 rounds.
 - Back bar-tacking → C (back feeding): 0-19 rounds.
D (forward feeding): 0-19 rounds.

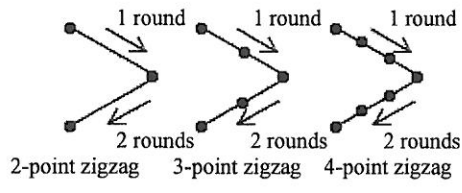

Click main interface circulating switch button to enter bar-tacking interface for setting.

6.1 Standard bar-tacking

Standard bar-tacking concept: Bar-tacking at the same start point as the zigzag pattern of the current pattern.

Example: Back bar-tacking



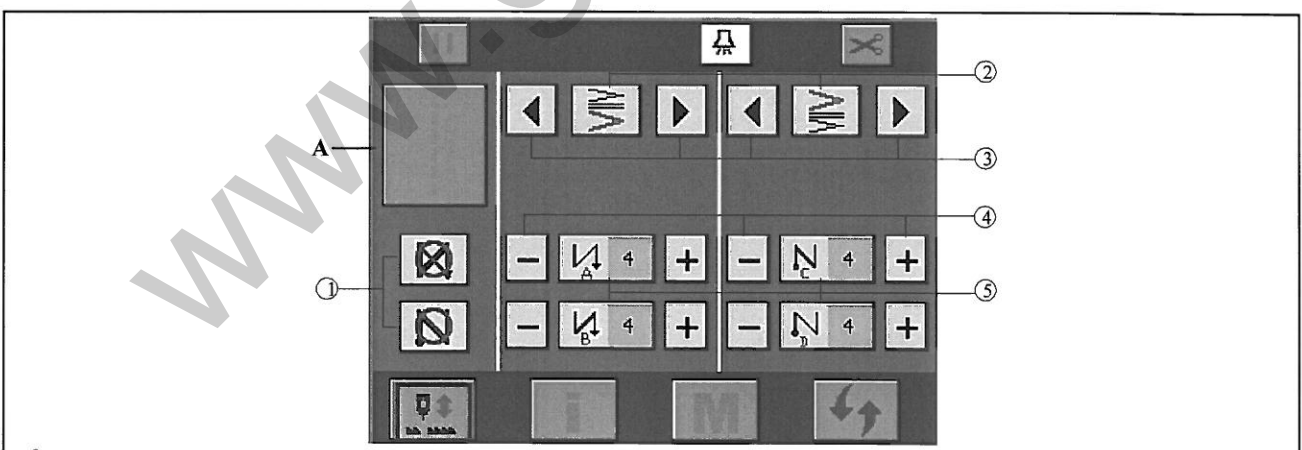
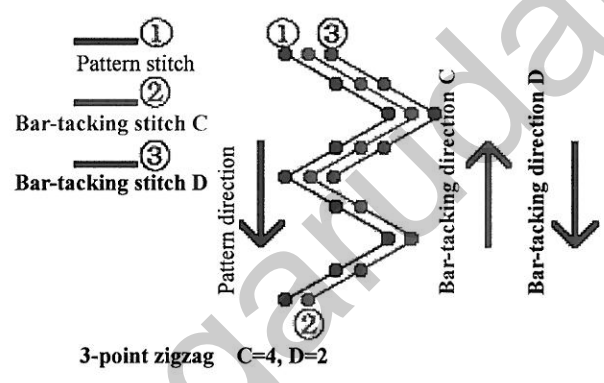







Sewing sequence is: ①→②→③.



Depending on the needle zigzag pattern, ABCD procedure can be classified into two types. See “Two settings of bar-tacking” of this chapter.

Please read the following table to get familiar with the interface elements and their functions.

| | |
|--------------------|--|
| A: Current pattern | Display the current pattern. The displayed contents depend on the specific pattern. |
|--------------------|--|

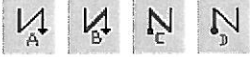
| | |
|--|---|
|  Please set standard bar-tacking in the following steps. | |
| ①: Front/back bar-tacking enable button  | → Click  to switch between  and  , i.e. disable or enable front bar-tacking. → Click  to switch between  and  , i.e. disable or enable back bar-tacking. |
| ②: Front/back bar-tacking state button  | → Display the types of front bar-tacking and back bar-tacking. Both are standard bar-tacking currently. |
| ③: Front/back bar-tacking type circulating switch button  | → Click this button to switch front/back bar-tacking in three types respectively. The sequence is: Standard bar-tacking->2-point shirring->customized bar-tacking->standard bar-tacking->.... |
| ④: Front/back bar-tacking A, B, C, D operation stitches (rounds)  | → Revise the number of stitches (or rounds) of A, B, C, D operations. |
| ⑤: Front/back bar-tacking A, B, C, D operation stitches (rounds) display button  | → Display the number of stitches (or rounds) of A, B, C, D operations. → Click this button to enter Slipper Setting Interface for stitch (or round) number setting. |

Example: for 2-point zigzag free sewing

- 1) Press  to display bar-tacking setting screen.
- 2) Set the type and rounds of bar-tacking (2-point zigzag is taken as example, so the setting unit is number of rounds).

At ② pattern:





- ③: See the type of front bar-tacking.
- ④: Set the rounds for A and B operations with “+/-“ respectively.

At ② pattern:

- ③: See the type of back bar-tacking.
- ④: Set the rounds for C and D operations with “+/-“ respectively.

- 3) Enable front bar-tacking and back bar-tacking.

At ① pattern:

- Click  to switch the icon to , front bar-tacking is active;
 Click  to switch the icon to , back bar-tacking is active;

6.2 2-point shirring



2-point shirring concept: Allow bar-tacking between the current start point and the next start point of the current pattern.



The width between the two points can be adjusted in the arrow direction.





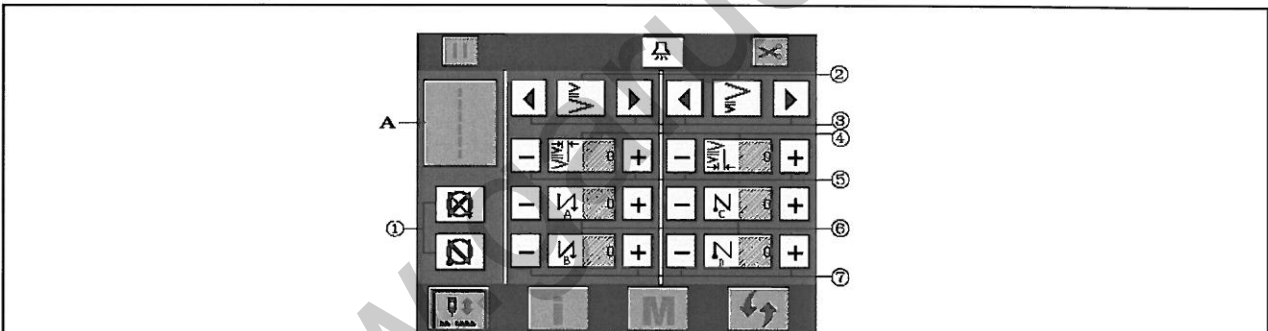
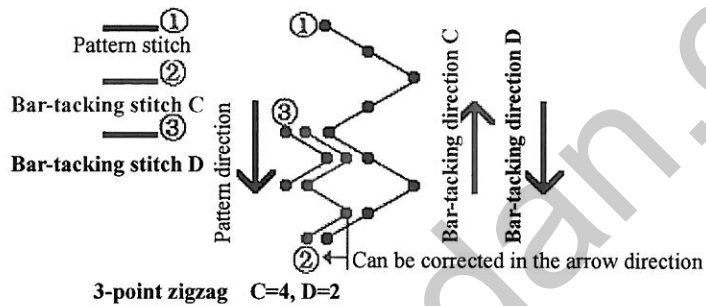





Example: Back bar-tacking





Sewing sequence is: ①→②→③.

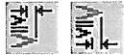

⚠ Depending on the needle zigzag pattern, ABCD procedure can be classified into two types. See “Two settings of bar-tacking” of this chapter.

⚠ Please read the following table to get familiar with the interface elements and their functions.

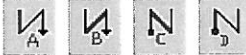
| | |
|--|---|
| A: Current pattern | → Same as standard bar-tacking |
| ⚠ Please set 2-point shirring in the following steps. | |
| ①: Front/back bar-tacking enable button   | → Click  to switch between  and  , i.e. disable or enable front bar-tacking. → Click  to switch between  and  , i.e. disable or enable back bar-tacking. |
| ②: Front/back bar-tacking state button   | → Display the types of front bar-tacking and back bar-tacking. Both are 2-point shirring currently. |
| ③: Front/back bar-tacking type circulating switch button | → Click this button to switch front/back bar-tacking in three types respectively. The sequence is: |

| | |
|--|---|
|  | Standard bar-tacking->2-point shirring->customized bar-tacking->standard bar-tacking->.... |
| ④: 2-point shirring distance display button  | → Display the shirring distance between 2 points. → Click this button to enter Slipper Setting Interface for shirring distance setting. . |
| ⑤: 2-point shirring distance adjust button  | → Adjust the shirring distance between 2 points. |
| ⑥: Front/back bar-tacking A, B, C, D operation stitches (rounds) display button  | → Display the number of stitches (or rounds) of A, B, C, D operations. → Click this button to enter Slipper Setting Interface for stitch (or round) number setting. . |
| ⑦: Front/back bar-tacking ABCD procedure stitches (rounds)  | → Revise the number of stitches (or rounds) of A, B, C, D operations. |

Example: for 2-point zigzag free sewing

- 1) Press  to display bar-tacking setting screen.
- 2) Set the type and rounds of bar-tacking (2-point zigzag is taken as example, so the setting unit is number of rounds).

At ② pattern:

- ③: See the type of front bar-tacking.
- ⑦: Set the rounds for A and B operations with “+/-“ respectively.

At ② pattern:

- ③: See the type of back bar-tacking.
- ⑦: Set the rounds for C and D operations with “+/-“ respectively.

- 3) Set the shirring distance between 2 points.

- ⑤: Set the shirring distance between 2 points with “+/-“ respectively.

- 4) Enable front bar-tacking and back bar-tacking.

At ① pattern:

Click  to switch the icon to , front bar-tacking is active;

Click  to switch the icon to , back bar-tacking is active;

6.3 Customized bar-tacking

 Customized bar-tacking concept: Bar-tacking between any entered start points.

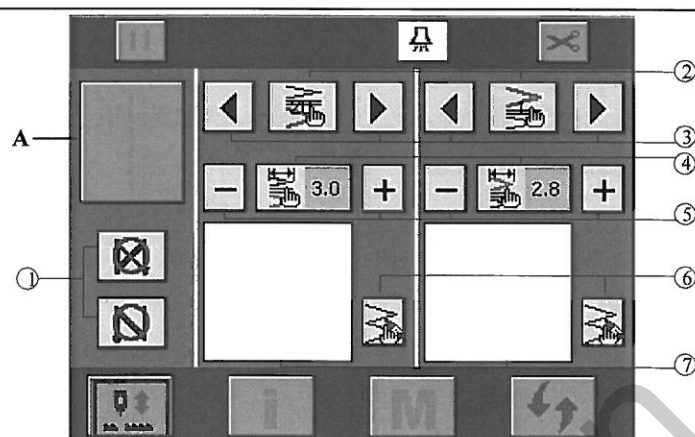













 The displayed contents depend on the specific setting.

 Please read the following table to get familiar with the interface elements and their functions.

A: Current pattern → Same as standard bar-tacking

 Please set customized bar-tacking in the following steps.

| | |
|---|--|
| <p>①: Front/back bar-tacking enable button</p>  | <p>→ Click  to switch between  and , i.e. disable or enable front bar-tacking.</p> <p>→ Click  to switch between  and , i.e. disable or enable back bar-tacking.</p> |
| <p>②: Front/back bar-tacking state button</p>  | <p>→ Display the customized front bar-tacking and back bar-tacking numbers. Both are customized bar-tacking 1 currently.</p> |
| <p>③: Front/back bar-tacking type circulating switch button</p>  | <p>→ Click this button to switch front/back bar-tacking in three types respectively. The sequence is: Standard bar-tacking->2-point shirring->customized bar-tacking->standard bar-tacking->....</p> |
| <p>④: Customized bar-tacking zigzag width display button</p>  | <p>→ Display the number of stitches (or rounds) of A, B, C, D operations.</p> <p>→ Click this button to enter Slipper Setting Interface for stitch (or round) number setting. .</p> |
| <p>⑤: Customized bar-tacking zigzag width setting button</p>  | <p>→ Revise the number of stitches (or rounds) of A, B, C, D operations.</p> |
| <p>⑥: Customized front/back bar-tacking start point edit button</p>  | <p>→ Click this button to enter Customized Start Point Setting Interface for pattern start point setting.</p> <p>See Customized Start Point Interface.</p> |
| <p>⑦: Start point shape display field</p> | <p>→ Display the start point shape of the current customized bar-tacking.</p> |

6.4 Comparison of bar-tacking for various patterns

| | Standard bar-tacking | | 2-point shirring | | Customized bar-tacking | |
|-----------------|----------------------|------------------|-------------------|------------------|------------------------|------------------|
| | Front bar-tacking | Back bar-tacking | Front bar-tacking | Back bar-tacking | Front bar-tacking | Back bar-tacking |
| Straight stitch | | | | | | |
| Other patterns | | | | | | |

7 Sewing mode setting

Click main interface circulating switch button to enter sewing mode interface for sewing mode setting.

7.1 Free sewing setting

As shown in the following figure, click mode circulating switch button ① to switch the current mode icon B to for free sewing setting.

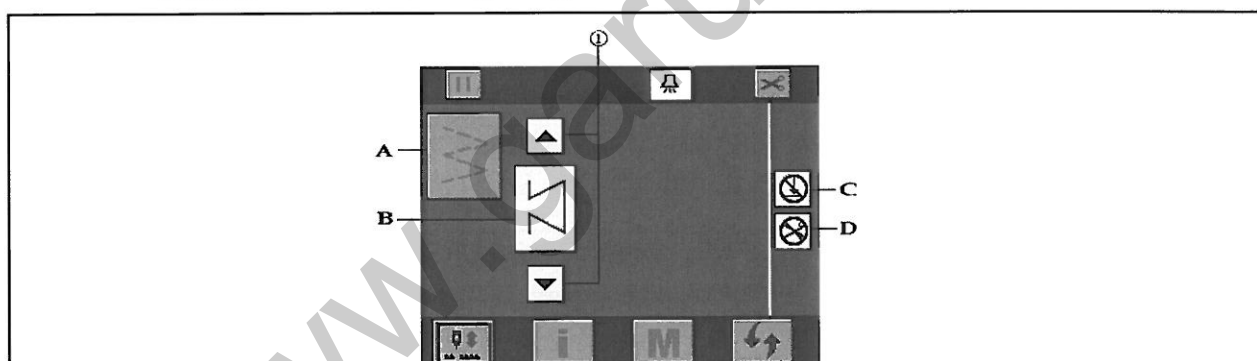

The displayed contents depend on the specific setting.

Please read the following table to get familiar with the interface elements and their functions.

| | |
|--------------------------------------|--|
| A: Current pattern | → It is 4-point zigzag currently. |
| B: Current bar-tacking mode | → Free sewing is displayed currently. |
| C: Trigger sewing activity mark | → Free sewing trigger sewing is inactive and inalterable. |
| D: Thread trimming activity mark | → Free sewing thread trimming is inactive and inalterable. |

⚠ Please set free sewing in the following steps.

①: Mode circulating switch button



→ Click this button to switch the mode among free sewing, overlapped sewing and programmed sewing circularly.

B corresponds to the following icons: . In this case, it is set as .

7.2 Overlapped sewing setting

As shown in the following figure, click mode circulating switch button ① to switch the current mode

icon B to for overlapped sewing setting.

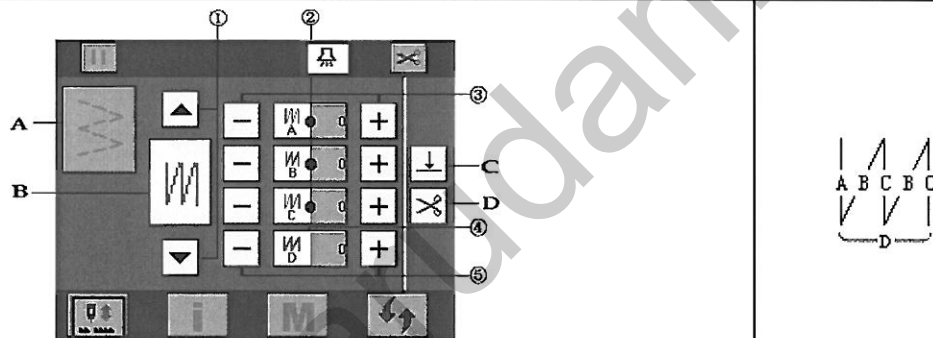

⚠ The displayed contents depend on the specific setting.

⚠ Please read the following table to get familiar with the interface elements and their functions.

A, B, C, D → Same as A, B, C and D of free sewing.

⚠ Please set overlapped sewing in the following steps.

①: Mode circulating switch button



→ Click this button to switch the mode among free sewing, overlapped sewing and programmed sewing circularly.

B corresponds to the following icons: → → . In this case, it is set as .

②: A, B, C operations stitch number display button

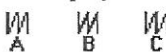

→ They indicate the number of stitches for A, B and C operations respectively.
→ Click this button to enter **Slipper Setting Interface** for stitch number setting for the relevant operation.
See “**Slipper setting interface**”.



③: A, B, C operations stitch number adjust button



→ Set the number of stitches of A, B, C operations, range: 0-19 stitches.

④: Operation number D display button

→ Display the total number of A, B, C operations.
→ Click this button to enter **Slipper Setting Interface** for total operation

| | |
|---|--|
|  | <p>number setting. See “Slipper setting interface”.</p> <p>⚠ Total number of operations: Total execution times of operations. Example: If D=5, operation A will be executed for 1 time, operation B 2 times, operation C 2 times; If D=8, operation A will be executed for 1 time, operation B 4 times, operation C 3 times.</p> |
| <p>⑤: Operation number D adjust button</p> <div style="text-align: center;">   </div> | <p>→ Adjust total number of operations with an increment/decrement of 1, range: 0-9.</p> |

👉 Setting sequence:

- a. Click ③ or ② to set the stitch number of A, B and C operations respectively in the range of 0-19.
- b. Click ⑤ or ④ to set the total operation number of D in the range of 0-9.

⚠ With every step on the pedal, forward/reverse sewing can be repeated for specified times, then thread trimming is done automatically to finish sewing.

⚠ If no auto trimming is required upon the end of sewing with needle at the upper stop position, set the auto trimming enable/disable mark to .

See “**Main interface description**”

7.3 Programmed sewing setting

👉 As shown in the following figure, click mode circulating switch button ① to switch the current mode



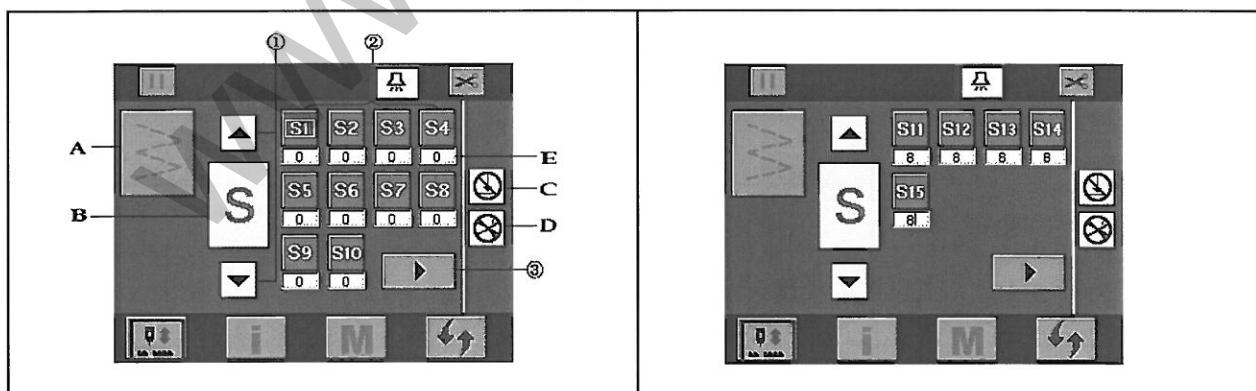





icon B to  for programmed sewing setting.







⚠ The displayed contents depend on the specific setting.





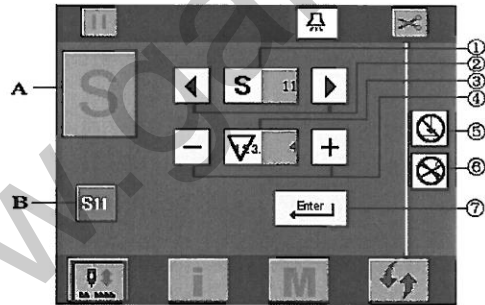





⚠ Please read the following table to get familiar with the interface elements and their functions.

| | |
|------------------------------------|---|
| A, B | → Same as A, B of free sewing. |
| C: Current trigger sewing activity | → Indicate the trigger sewing is active or not in the current section (inalterable) |

| | |
|---|---|
| mark  | in this interface). |
| D: Thread trimming activity mark  | → Indicate the thread trimming is active or not in the current section (inalterable in this interface). |
| ⚠ Please set overlapped sewing in the following steps. | |
| ①: Mode circulating switch button  | → Click this button to switch the mode among free sewing, overlapped sewing and programmed sewing circularly. B corresponds to the following icons:  →  →  . In this case, it is set as  . |
| ②: Programmed sewing operation mark button  | → The maximum number of operations depends on specific setting (up to 20 operations). → Click this button to enter Programmed Sewing Stitch Setting Interface. See “Programmed stitch setting interface” in this section. |
| ③: Page turning button  | → If the number of operations is greater than 10 (max. 20), it will be displayed. Click it to switch to the next page. |

 Programmed stitch setting interface

| | |
|---|---|
|  | |
| ⚠ The displayed contents depend on the specific setting. | |
| ⚠ Please read the following table to get familiar with the interface elements and their functions. | |
| A: Programmed sewing mark  | |
| B: Current target operation  | → Display the currently set operation number (No. 11 in this example) |
| ⚠ Please set programmed sewing in the following steps. | |
| ①: Operation number display button  | → Display the currently operation number (maximum 20) → Click this button to enter Keypad Setting Interface and select operation number to set. |

| | |
|---|---|
| | See “Keypad setting interface” |
| ②: Operation number selection button  | → Click this button ②, the current operation number will be switched to the previous or next operation. ⚠ If the current operation is the last one, an operation will be added when you click  . Up to 20 operations can be set. ⚠ If auto trimming is set active, disable it before adding operation. |
| ③: Stitch number display button  | → Display the number of stitches of the current operation (maximum 500). → Click this button to enter Keypad Setting Interface and set stitch number. See “ Keypad setting interface ” |
| ④: Stitch number adjust button  | → Click this button to increase or decrease 1 stitch. The max. is 500 stitches. |
| ⑤: Trigger sewing setting button  | → Trigger setting for specific operations of programmed sewing. Click it to switch between  and  , indicating inactive or active trigger. ⚠ Active trigger: When step on the pedal, one sewing for the current operation will be finished, and the machine prepares for next sewing. The sewing will not be terminated if the pedal is released during sewing. Inactive trigger: When step on the pedal, if the sewing for the current operation is not finished, it will be interrupted, and the pedal should be stepped again till the sewing is finished. |
| ⑥: Auto trimming setting button  | → Auto thread trimming setting for specific operations of programmed sewing. Click it to switch between  and  , indicating inactive or active auto trimming. ⚠ If the auto trimming is set active for the current operation, the current operation will be automatically set as the last operation. |
| ⑦: Setting confirmation button  | → After setting, click this button to save data and return to mode interface. ⚠ If the power is turned off without clicking this button, the set data will not be saved. |

8 Customization handling



Customization classification: Customized pattern and customized bar-tacking. The start point setting, copy and delete operations are the same for them.

8.1 Customized start point setting





Customized start point concept: To manually edit the start point shape of the customized pattern or customized bar-tacking.

 The start point of customized pattern can be set in two modes.

- 1) In **Customized Pattern Selection Interface**, select a null customized pattern number and click



- 2) In **Customization Attribute Interface**, click customization edit button  to enter it.

 The start point of customized bar-tacking can be set in two modes.

- 1) In **Customized Pattern Selection Interface**, select a null customized pattern number and click





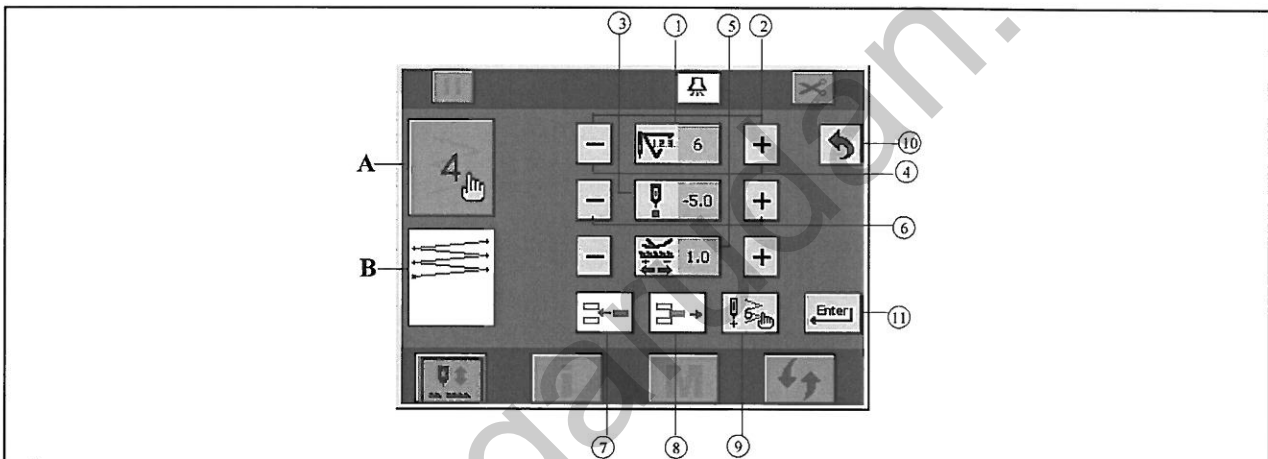









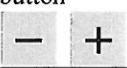

- 2) In bar-tacking interface, select **Customization Bar-tacking**, click customization edit button  to enter it.





 The displayed contents depend on the specific setting.

 Please read the following table to get familiar with the interface elements and their functions.

| | |
|--|---|
| <p>A: Customization (pattern or bar-tacking) number</p>  | <p>→ Display the number of the customization (pattern or bar-tacking) (customized pattern 4 in this example). For customized front bar-tacking 4, the displayed icon will be .</p> |
| <p>B: Customization (pattern or bar-tacking) display field</p> | <p>→ Display the shape of the current customization.</p> |
| <p> Please set customized start point in the following steps.</p> | |
| <p>①: Customized start point number display button</p>  | <p>→ Display the number of the current stitch. → Click this button to enter Keypad Setting Interface and set another stitch number.</p> |
| <p>②: Customized stitch number adjust button</p>  | <p>→ Adjust to the next or previous stitch, or call keypad for adjustment with ①.</p> |
| <p>③: Needle zigzag display button</p> | <p>→ Display the needle zigzag value for the current stitch number.</p> |

| | |
|--|---|
|  | → Click this button to enter Keypad Setting Interface for adjustment. |
| ④: Needle zigzag adjust button  | → Adjust 0.1mm to the left or right (fine adjustment). Alternatively, adjustment can be made by calling keypad with ③. |
| ⑤: Current stitch number feeding volume display button  | → Display the feeding volume setting for the current stitch number. → Click this button to enter Keypad Setting Interface for adjustment. |
| ⑥: Set the feeding volume for the current stitch number  | → Click this button to adjust the feeding volume for the current stitch number. |
| ⑦: 1 stitch insert button  | → Example: To insert a stitch between stitches 18 and 19, adjust to stitch 18 first, then click this button, a stitch will be inserted between stitches 18 and 19, and the original stitch 19 and subsequent stitch numbers will be increased by 1. |
| ⑧: 1 stitch delete button  | → Example: To delete stitch 18, adjust to stitch 18 first, then click this button, this stitch will be deleted, and the original stitch 19 and subsequent stitch numbers will be decreased by 1. |
| ⑨: End stitch setting button  | → Example: To set stitch 18 as the last stitch, adjust to stitch 18 first, then click this button, stitch 18 will be set as the last stitch, and the subsequent stitches will be invalid. |
| ⑩: Return button  | → If no operation nor operation saving is needed, click this button to return. |
| ⑪: Confirm button  | → After the above setting, click this button to save the operation result. |

8.2 Customization copy and delete

- ☞ After customized pattern or bar-tacking is set, it can be copied to other null customization numbers or deleted.
- ☞ Customized pattern copy and delete: In **Customized Pattern Attribute Interface**, click customization edit button  to enter it.
- ☞ Customized bar-tacking copy and delete: In **Bar-tacking Setting Interface**, select customized bar-tacking, and click customization edit button  to enter it.

Example: The copy and delete interface of pattern 1 of customized pattern is shown currently.

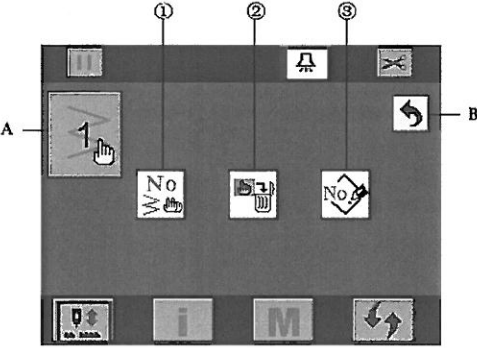

A: Type and number of the current customization;
 B: Return button, without setting;

①: Click it to enter customization copy interface;
 ②: Click it to delete the current customized pattern or bar-tacking;
 ③: Not used at present.

⚠ The displayed contents depend on the specific setting.

 Customization copy interface

Example: Copy pattern 1 to No. 2

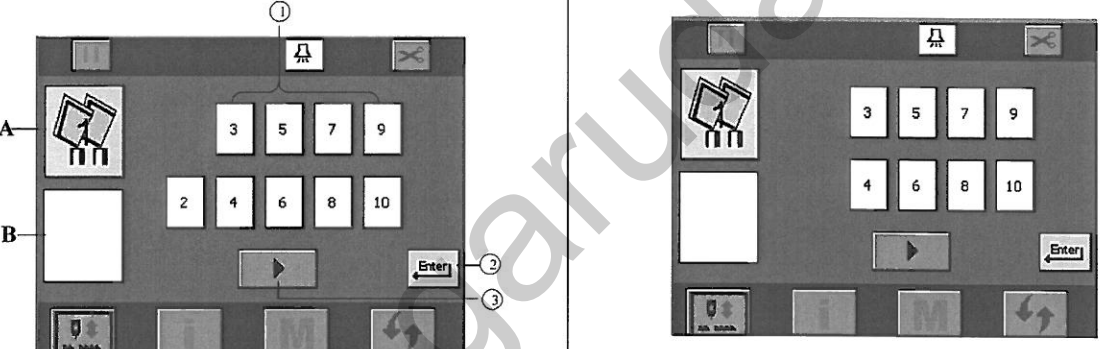

⚠ The displayed contents depend on the specific setting.



⚠ Please read the following table to get familiar with the interface elements and their functions.

| | |
|----|--|
| A: | → Indicates the current state of pattern 1 copy |
| B: | → Display the preview of the copied customized pattern |

⚠ Please set overlapped sewing in the following steps.

| | |
|------------------------|---|
| ①: Null pattern field | → Click No. 2 button in this field to copy pattern 1 to No. 2, and No. 2 button will disappear. |
| ②: Confirm button | → Click to return to the previous interface |
| ③: Page turning button | → Enter the next page for further copy operation |

9 System management setting (M interface)

 In Main Interface, click  to enter System Management Setting Interface.

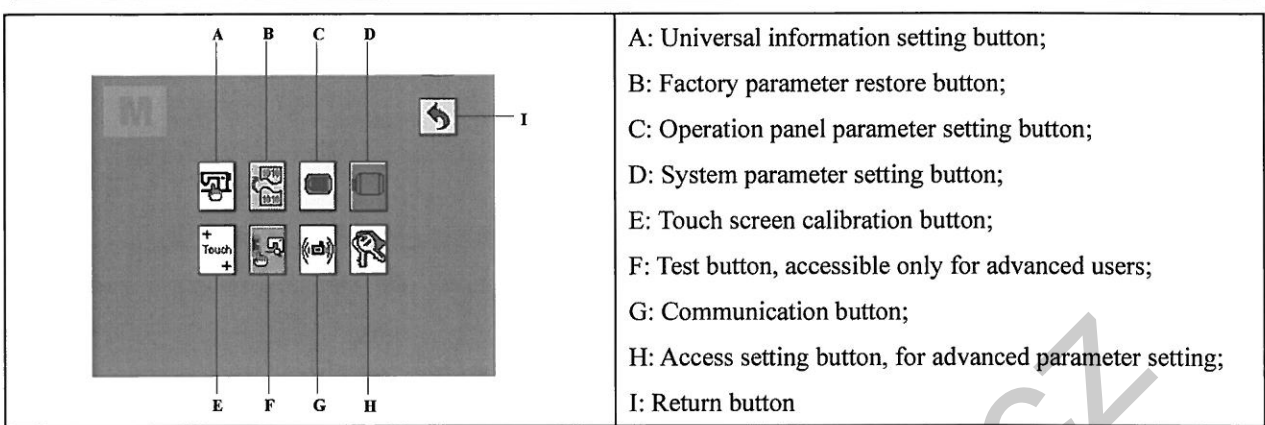



9.1 Universal parameter setting

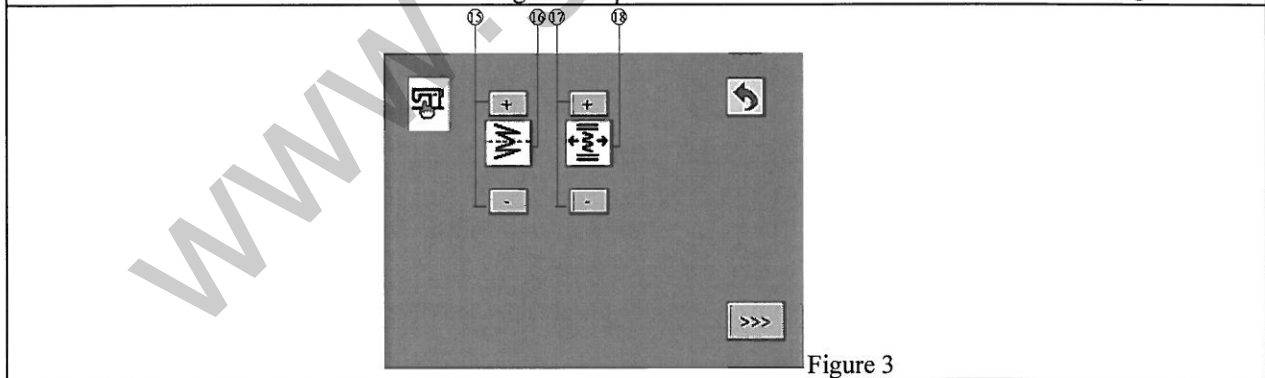
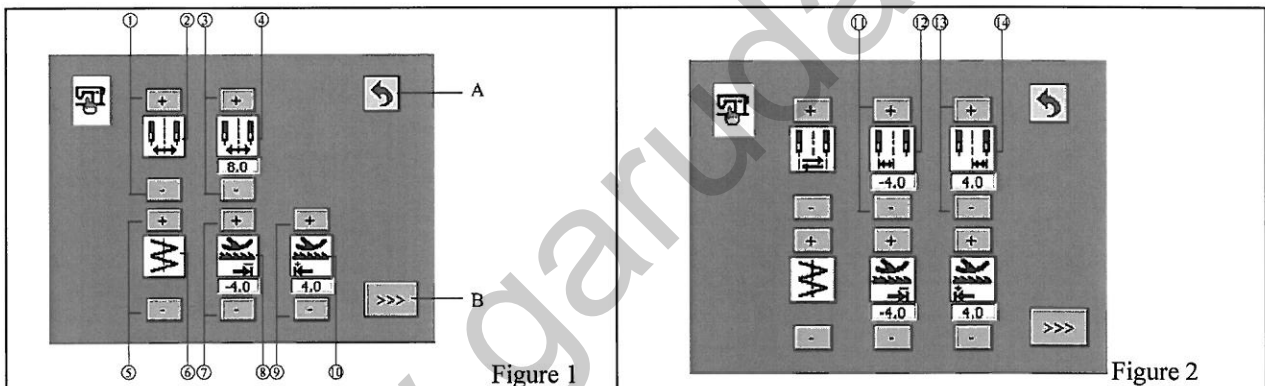





















In System Management Setting Interface, click to enter Universal Parameter Setting Interface.



⚠ Please read the following table to get familiar with the interface elements and their functions.



| | |
|---|---|
| A: Return button  | → Return to the previous interface |
| B: Page turning button  | → Enter universal information setting page 2. |

⚠ Please set system universal information in the following steps.

| | |
|--|---|
| <p>? Symmetrical reversion: During sewing, press symmetrical reversion switch to perform symmetrical sewing, including single pattern reversion and continuous reversion.</p> <ol style="list-style-type: none"> 1) Single pattern reversion: Only one pattern is reversed. After reversed sewing, return to the original pattern; 2) Continuous pattern reversion: After reversion, the reversed pattern sewing will be continued unless the thread is cut or the symmetrical reversion switch is pressed again. <p>? Customized bar-tacking reference line position: When the system reference line is of central reference, for the reference line of customized bar-tacking, the action mode will be:</p> <ol style="list-style-type: none"> 1) Interlocked: The reference line position of the customized bar-tacking will be moved with that of needle zigzag pattern; 2) Fixed: The customized bar-tacking will be fixed at the position of the entered data. | |
| <p>①: System zigzag width selection button</p>  | <p>→ Click this button to switch system zigzag setting icon ② between Central symmetry  and left/right limit  modes. See ③, ⑦, ⑨.</p> |
| <p>③: System central symmetry zigzag width setting button</p>  | <p>→ Click this button to revise the zigzag value of central symmetry mode in the range of 0-10mm.</p> <p>→ It can also be set by clicking ④:  to call Keypad Setting Interface.</p> |
| <p>⑤: System reference line adjust button</p>  | <p>→ Click this button to switch system reference line icon ⑥ between Left reference  , central reference  and right reference .</p> |
| <p>⑦: System reverse feeding volume limit adjust button</p>  | <p>→ Click this button to revise the limit for system reverse feeding volume in the range of -5.0-5.0mm.</p> <p>→ It can also be set by clicking ⑧:  to call Keypad Setting Interface.</p> |
| <p>⑨: System forward feeding volume limit adjust button</p>  | <p>→ Click this button to revise the limit for system forward feeding volume in the range of -5.0-5.0mm.</p> <p>→ It can also be set by clicking ⑩:  to call Keypad Setting Interface.</p> |
| <p>⑪: System zigzag width left limit setting button</p>  | <p>→ Click this button to revise the left limit of zigzag in the range of 0-10mm.</p> <p>→ It can also be set by clicking ⑫:  to call Keypad Setting Interface.</p> |
| <p>⑬: System zigzag width right limit setting button</p>  | <p>→ Click this button to revise the right limit of zigzag in the range of 0-10mm.</p> <p>→ It can also be set by clicking ⑭:  to call Keypad Setting Interface.</p> |
| <p>⑮: Symmetrical reversion function setting button</p>  | <p>→ Click this button to switch symmetrical reversion function icon ⑯ between Single pattern symmetrical reversion  and continuous symmetrical reversion .</p> |
| <p>⑰: Customized bar-tacking reference line setting button</p>  | <p>→ Click this button to switch bar-tacking reference line icon between Interlocked  and fixed .</p> |

9.2 Factory parameter restore

 This operation will not restore the data of customized pattern and customized bar-tacking.

 In **System Management Setting Interface**, click  to enter Factory Parameter Restore Setting Interface.

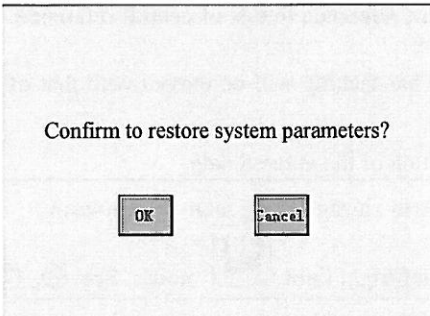
| | |
|---|---|
|  | <ol style="list-style-type: none"> 1) Confirm: Click Enter to restore the system to factory parameters (power off and restart are required). 2) Cancel: Click Cancel button to exit factory parameter restore interface and cancel the operation. |
|---|---|

9.3 Operation panel parameter setting

 In System Management Setting Interface, click  to enter Operation Panel Parameter Setting Interface.

Example: Take H01 operating box key sound enabling as an example.

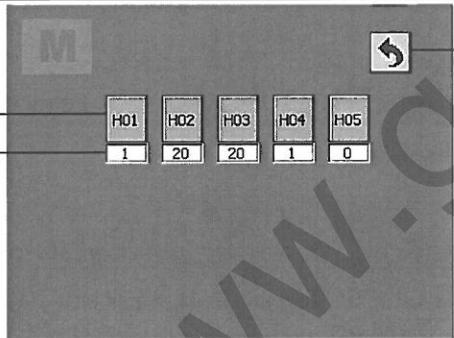
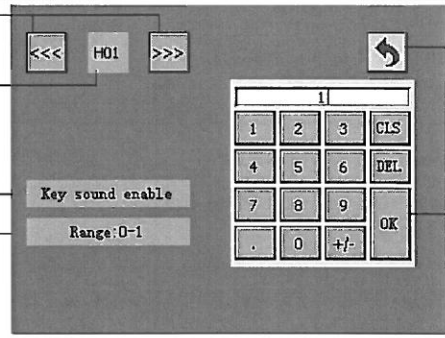
| | |
|---|--|
|  <p style="text-align: center;">Figure 1</p> |  <p style="text-align: center;">Figure 2</p> |
| <p>A: Operating box parameter display value; B: Return button; C: Current parameter number; D: Function description corresponding to the current number; E: Current parameter setting range</p> | <p>①: Operating box parameter number, click it to enter Figure 2; ②: Click it to go to the previous or next number; ③: Keypad Setting Interface, for value setting of the number</p> |

9.4 System parameter setting

 In System Management Setting Interface, click  to enter System Parameter Setting Interface.

Example: take P01 soft start function as an example.

| | |
|---|--|
| <p style="text-align: center;">Figure 1</p> | <p style="text-align: center;">Figure 2</p> |
| <p>A: System parameter number set value; B: Return button; C: Current parameter number; D: Function description corresponding to the current number; E: Current parameter setting range</p> | <p>①: System parameter number, click it to enter Figure 2; ②: Page turning button; ③: Click it to go to the previous or next number; ④: Keypad Setting Interface, for value setting of the number</p> |

9.5 Touch screen calibration setting

In System Management Setting Interface, click to enter Touch Screen Calibration Interface.

| | |
|--|--|
| | <p>→ The calibration interface is shown in the left figure, please the center of + prompted on the screen (4 times).</p> <p>→ After calibration, the calibration error is displayed on the screen automatically. With a small error, the calibration is successful, the system exits this interface automatically; with a great error, the screen will display the error value and “touch screen calibration failed, please recalibrate it” and return to the calibration interface.</p> |
|--|--|

9.6 Test run

For professionals only.

Test run function is intended to test the operation of all modules of the machine. The following functions vary with the configuration of the machine purchased.

Button is accessible only for advanced users, see the next section: Access setting.

In System Management Setting Interface, click to enter aging setting.

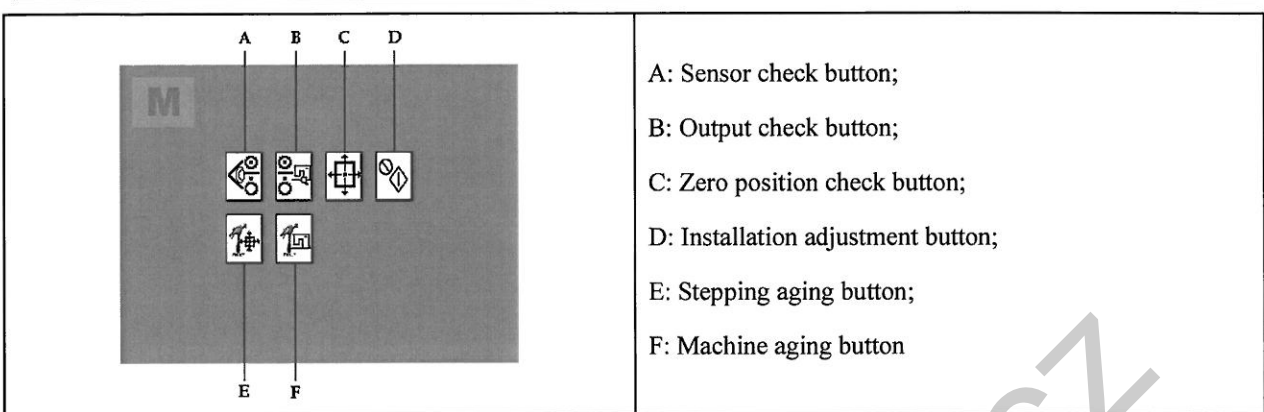

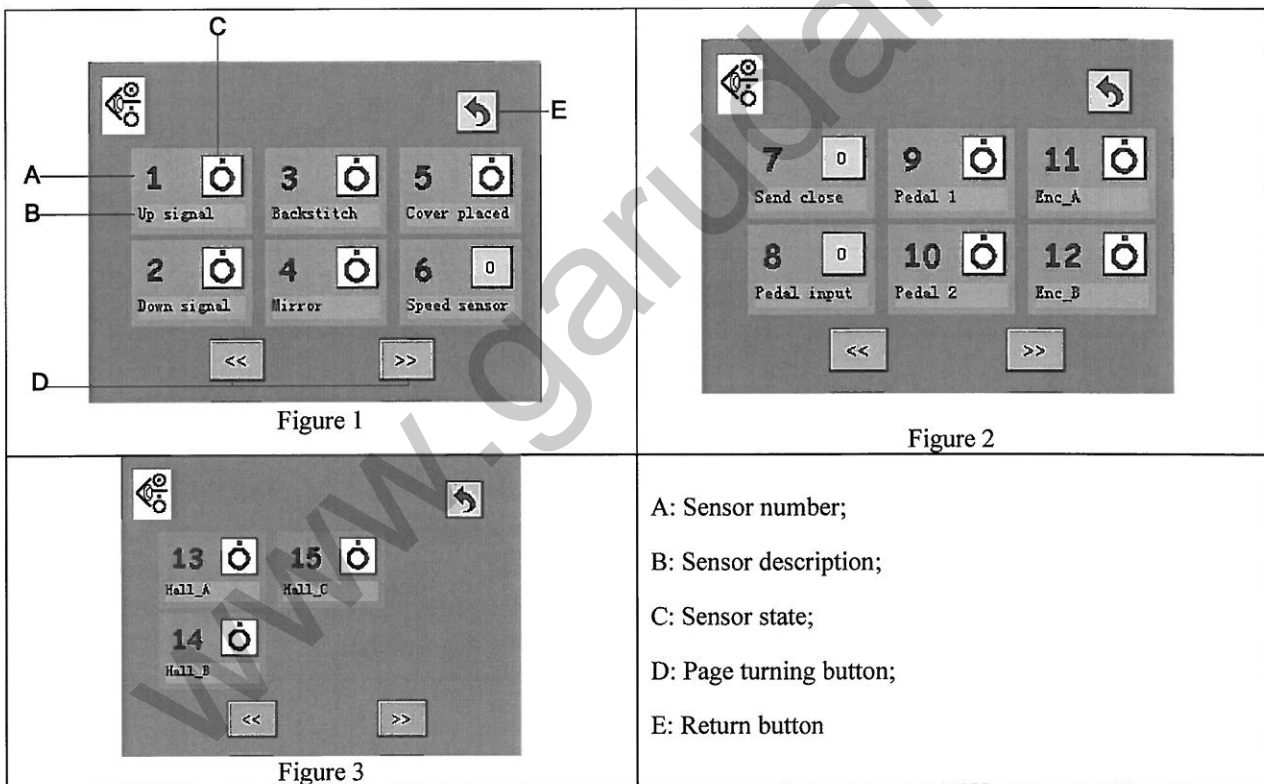

9.6.1 Sensor check test

 In Aging Interface, click  to enter Sensor Check Interface.





 Function explanation:

| No. | Description |  |  |
|----------------------------|----------------------------------|---|---|
| 1. Up | Upper needle stop sensor state | Up signal low level | Up signal high level |
| 2. Dn | Lower needle stop sensor state | Dn signal low level | Dn signal high level |
| 3. Reverse sewing switch | Reverse sewing switch state | Reverse sewing switch On | Reverse sewing switch Off |
| 4. Mirror image switch | Mirror image switch state | Mirror image switch On | Mirror image switch Off |
| 5. Head lift switch | Head lift switch state | Head lift switch On | Head lift switch Off |
| 6. Speed lever input | Operating box speed lever analog | Turn operating box speed lever, the display value changes in the range of 0-255. | |
| 7. HMI feeding lever input | Reserved | | |
| 8. Pedal input | Pedal analog | When the pedal is stepped, the display value changes in the range of 0-255. | |
| 9. Pedal 1 | Pedal state quantity 1 | Pedal stop, pedal operate | Pedal presser foot lift, pedal thread trimming |
| 10. Pedal 2 | Pedal state quantity 2 | Pedal thread trimming, pedal operate | Pedal presser foot lift, pedal stop |
| 11. Enc_A | Motor encoder signal Enc_A | Enc_A signal low level | Enc_A signal high level |
| 12. Enc_B | Motor encoder signal Enc_B | Enc_B signal low level | Enc_B signal high level |
| 13. Hall_A | Motor encoder signal Hall_A | Hall_A signal low level | Hall_A signal high level |
| 14. Hall_B | Motor encoder signal Hall_B | Hall_B signal low level | Hall_B signal high level |
| 15. Hall_C | Motor encoder signal Hall_C | Hall_C signal low level | Hall_C signal high level |

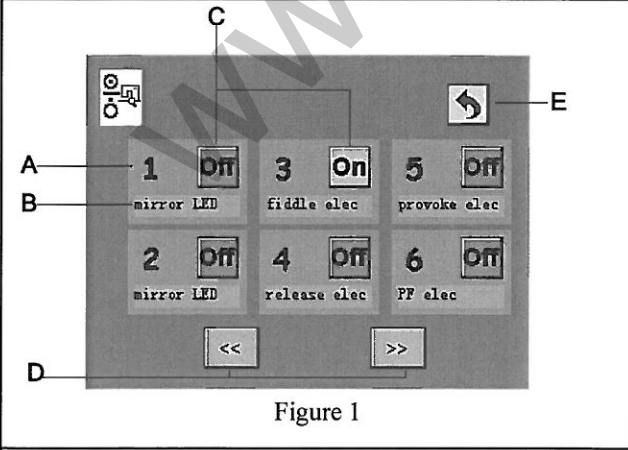
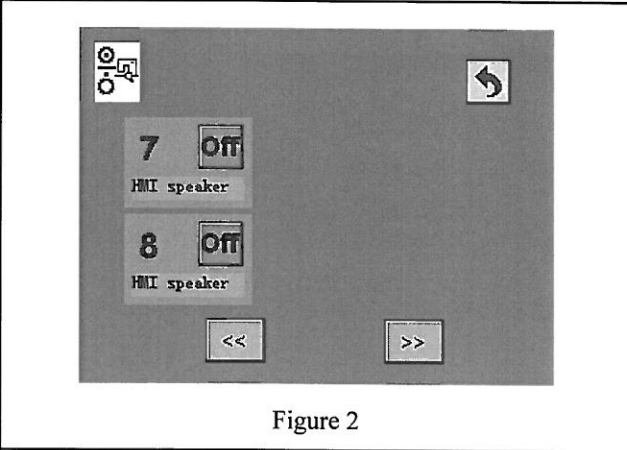

9.6.2 Output check test

 In Aging Interface, click  to enter **Sensor Check Interface**.

| | |
|---|--|
|  <p>Figure 1</p> |  <p>Figure 2</p> |
| <p>A: Number;</p> | <p>Please observe the relevant hardware action of the sewing</p> |

| | |
|--|---|
| B: Description; C: Output setting, click it to switch between  and  . | machine; D: Page turning button; E: Return button |
|--|---|

 Function explanation:

| No. | Description |  |  |
|------------------------------|-------------------------------|---|---|
| 1. Mirror image LED | Mirror image switch indicator | Mirror image LED On | Mirror image LED Off |
| 2. Thread trimming solenoid | Thread trimming solenoid | Thread trimming solenoid operates once | Thread trimming solenoid off |
| 3. Thread wiping solenoid | Thread wiping solenoid | Thread wiping solenoid operates once | Thread wiping solenoid off |
| 4. Thread releasing solenoid | Thread releasing solenoid | Thread releasing solenoid operates once | Thread releasing solenoid off |
| 5. Thread take-up solenoid | Thread take-up solenoid | Thread take-up solenoid operates once | Thread take-up solenoid Off |
| 6. Presser foot solenoid | Presser foot solenoid | Presser foot solenoid operates once | Presser foot solenoid Off |
| 7. Operating box speaker | Operating box speaker | Operating box speaker sounds once | Operating box speaker Off |
| 8. Reverse sewing solenoid | Reverse sewing solenoid | Reverse sewing solenoid operates once | Reverse sewing solenoid Off |

9.6.3 Zero position check test

 In Aging Interface, click  to enter **Zero Position Check Interface**.

A: Zigzag zero position state;

Zigzag zero position: ; non zero position: .

①: Click it to return to zigzag zero position automatically;

②: Adjust zigzag to return to zero position gradually, observe zero position state by mark A;

B: Fabric feeding zero position state;

Fabric feeding zero position: ; non zero position: .

③: Click it to return to fabric feeding zero position automatically;

④: Adjust fabric feeding to return to zero position gradually, observe zero position state by mark B;

C: Return button





9.6.4 Installation adjustment test

In Aging Interface, click to enter Installation Adjust Test Interface. The tested pattern is 3-point zigzag stitch.

Please read the following table to get familiar with the interface elements and their functions.

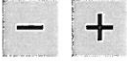
| | |
|----------------------|---|
| A: Tested pattern | → The tested pattern is 3-point zigzag. |
| B: Return button | → Return to the previous interface |

Please set installation adjustment in the following steps. The test run can be conducted after setting.

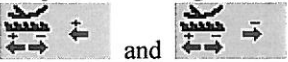

| | |
|---|--|
| ②: Adjust test zigzag width  | → Click this button to set test zigzag width. It can also be set by clicking button ①  to call Keypad Setting Interface . |
| ④: Adjust test reference line  | → Click this button to change the reference line to left, central or right mode. Mark ③ shows L, M, R respectively. |
| ⑥: Adjust test feeding direction  | → Click this button to adjust the feeding direction to forward or reverse. Mark ⑤ shows  respectively. |

9.6.5 Stepping aging test

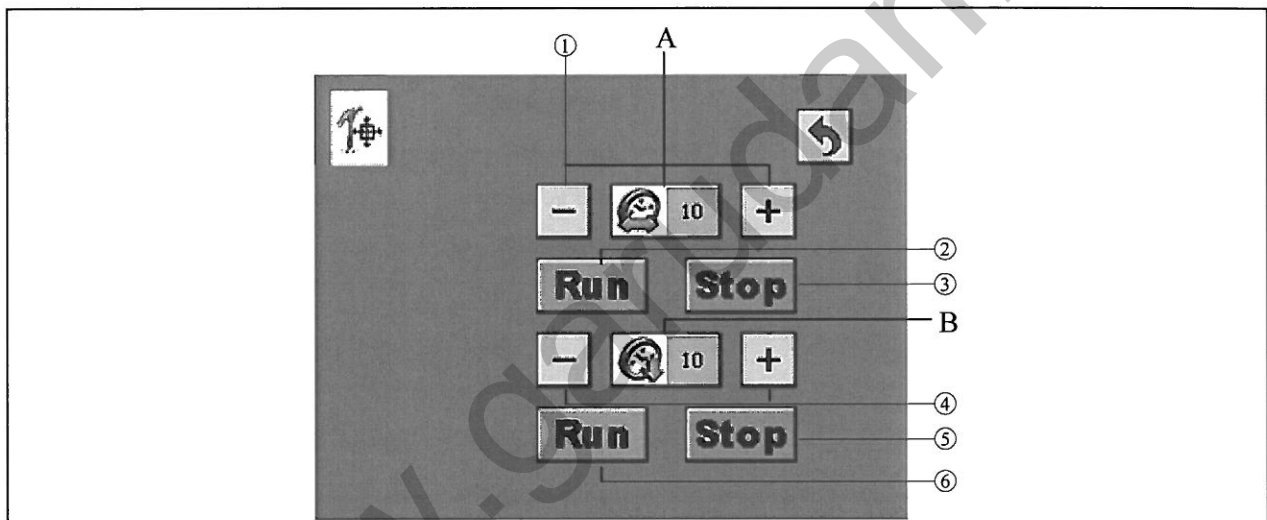

 In Aging Interface, click  to enter Stepping Aging Test Interface.







⚠ Please read the following table to get familiar with the interface elements and their functions.

| | |
|---|-------------------------|
| A: Zigzag aging mark and zigzag interval  | → The interval is 10ms. |
| B: Feeding aging mark and feeding interval  | → The interval is 10ms. |

⚠ Please set stepping aging in the following steps. The test run can be conducted after setting.

| | |
|--|--|
| ①: Adjust zigzag stepping zigzag interval  | → Click this button to set zigzag stepping zigzag interval |
| ②: Zigzag machine stop button  | → Click this button to stop zigzag stepping test. |

| | |
|---|---|
| ③: Zigzag machine run button  | → Click this button to stop zigzag stepping test. |
| ④: Adjust feeding stepping zigzag interval  | → Click this button to set feeding stepping interval |
| ⑤: Machine stop button  | → Click this button to stop feeding stepping test. |
| ⑥: Test feeding direction adjust button  | → Click this button to start feeding stepping aging test. |

9.6.6 Machine aging test

 In Aging Interface, click  to enter Machine Aging Test Interface.

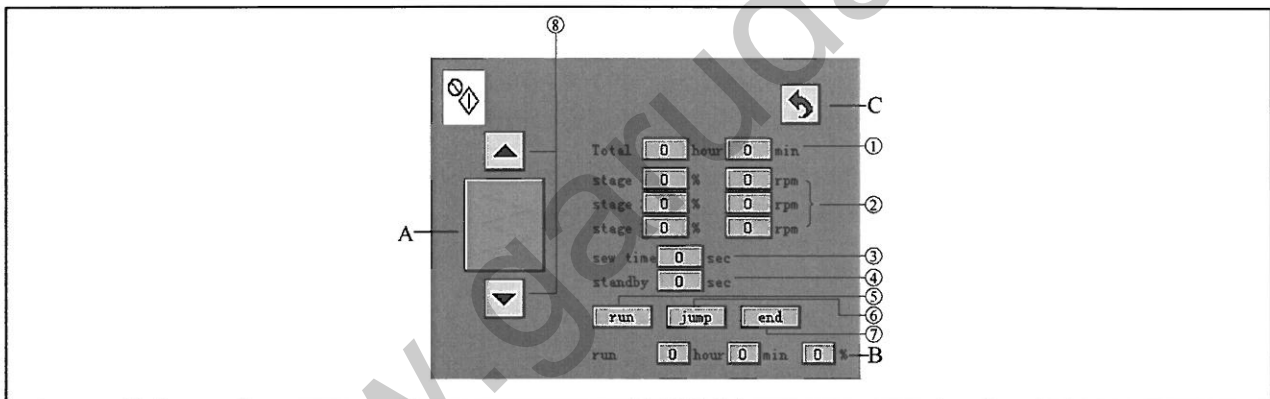





⚠ Please read the following table to get familiar with the interface elements and their functions.

| | |
|--------------------------|--|
| A: Current aging pattern | → Aging pattern is optional. |
| B: Aging progress | → Display the elapsed aging time and percentage. |
| C: Return button | → Return to the previous interface |

⚠ Please set machine aging in the following steps. The test run can be conducted after setting.

⚠ During operation, buttons except for ⑤ and ⑦ are disabled.

| | |
|---|--|
| ①: Total aging time setting | → Click it to call Keypad Setting Interface to set total aging time. |
| ②: Setting of Phase 1, 2 or 3 | → Click it to call Keypad Setting Interface to set the percentage and speed for the corresponding phase. |
| ③: Continuous operation time | → Click it to call Keypad Setting Interface to set operation time. |
| ④: Stand-by time | → Click it to call Keypad Setting Interface to set the stand-by time after operation. |
| ⑤: Run  | → After setting of ①-④, click this button to start operation. During operation this button appears  . |

| | |
|--|--|
| ⑥: Jump  | → To change the aging progress during operation, click ⑤ to stop the sewing machine and click this button to call Keypad Setting Interface, set the progress percentage, click Enter, and restart the machine. |
| ⑦: End  | → Click this button to manually end the aging process. |

9.7 Communication function

Communication function allows to download sewing data programmed on other sewing machines or stored in SD card to the sewing machine. Additionally, it allows to upload the above data to SD card or computer.

9.7.1 Inserting memory card

Before using SD card, make sure the SD card has been formatted as FAT16 or FAT32.

The operating box can only process the files named by digits with an extension name of .JZQ. For JZQ file generation method, refer to relevant helps.

Put the files to process into jizhi folder of SD card. If no jizhi folder exists in SD card, please create one.

 If the file is not saved in the correct folder, it cannot be read.

Follow the following steps:

- (1) Set the LOCK switch of SD card to UNLOCK. LOCK switch is on the left of the front side of SD card.
- (2) Open the cover on the right of the operating box, insert the SD card into the SD card interface of the operating box with the contact on SD card directed forward.



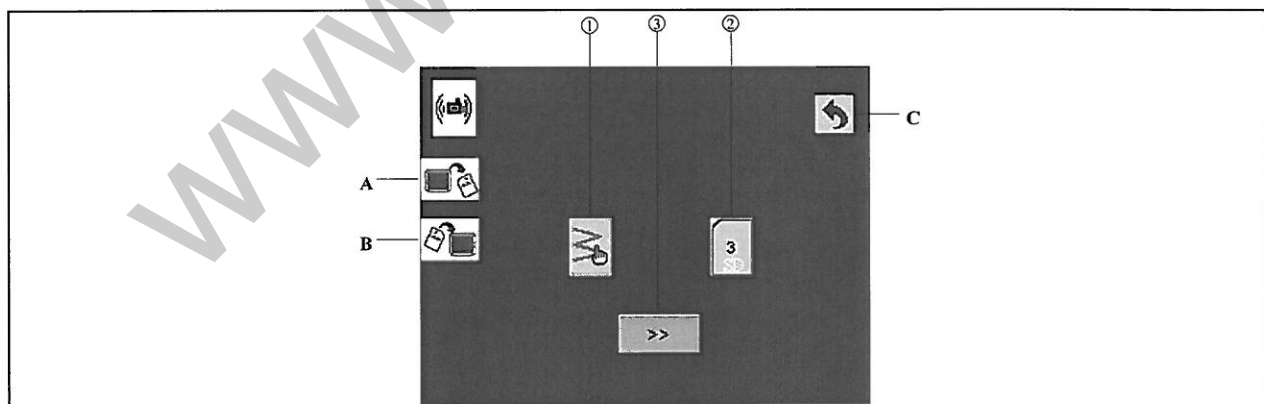

9.7.2 Selecting transmission direction

 In System Management Setting Interface, click  to enter Communication Interface.





 Please read the following table to get familiar with the interface elements and their functions.

| | |
|----------------------------------|--|
| A: From operating box to SD card | → Export the pattern from operating box to SD card |
| B: From SD card to operating box | → Export the pattern from SD card to operating box |
| C: Return button | → Return to the previous interface |

| | |
|---|--|
| <p>⚠ When select button A functions, ① is , ② is . When select button B functions, ① is , ② is .</p> <p>⚠ When the communication direction is selected, select pattern number according to the following table.</p> | |
| ①: Source pattern number selection | → Click it to select the source pattern for communication. |
| ②: Target pattern number selection | → Click it to select the target pattern for communication. |
| ③: Communication button. | <p>→ When the source and target pattern numbers are selected, click it to transmit pattern.</p> <p>⚠ Only when the source and target pattern numbers are selected, can the transmission button be used.</p> <p>⚠ Patterns over 60 stitches cannot be introduced into the customized bar-tacking pattern of the sewing machine.</p> |

9.7.3 Operating box pattern selection

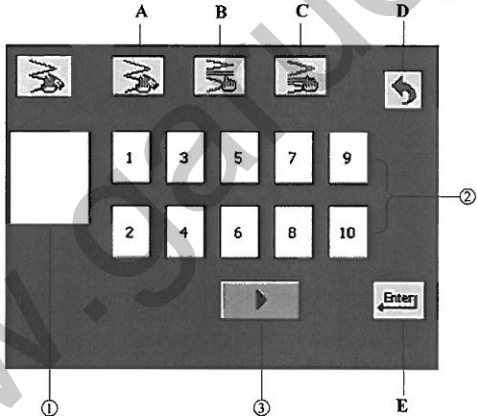

 In Communication Interface, click  to enter operating box pattern selection interface.

| | |
|---|--|
|  | |
| <p>⚠ Please read the following table to get familiar with the interface elements and their functions.</p> | |
| A: Customizing pattern selection | → Select customized patterns in operating box |
| B: Customized front bar-tacking pattern selection | → Select customized front bar-tacking patterns in operating box |
| C: Customized back bar-tacking pattern selection | → Select customized back bar-tacking patterns in operating box |
| D: Return button | → Return to the previous interface |
| E: Confirm button | → Confirm the current selection and return to the previous interface |
| <p>⚠ Pattern selection function:</p> | |
| ①: Pattern display field | → Display the current selected pattern stitch |
| ②: Pattern selection button | → Click it to select pattern number. |
| ③: Page turning button | → Enter the next page |

9.7.4 SD card file selection

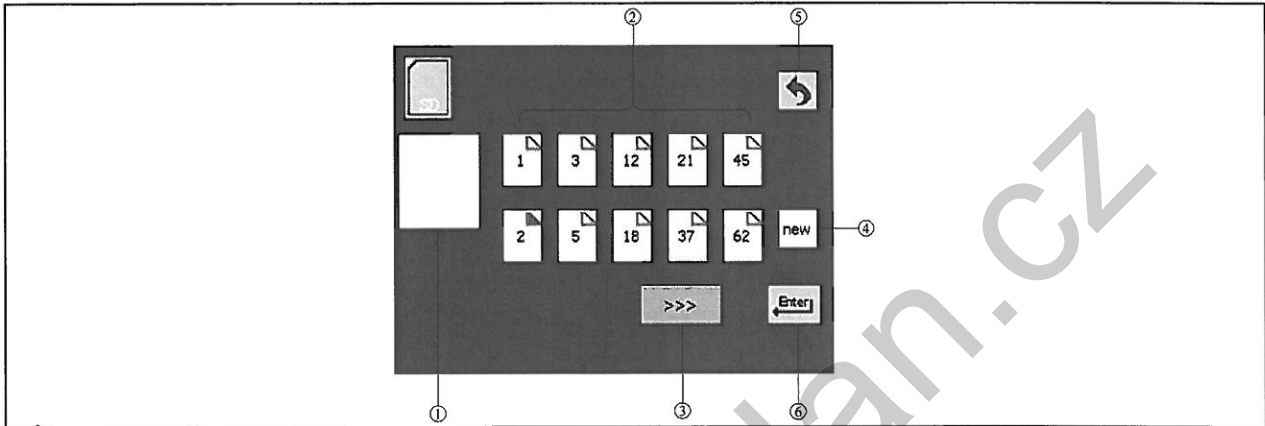
 In Communication Interface, click  to enter SD card pattern selection interface.



| | |
|--|--|
| <p> JZQ files in jizhi folder of SD card will be displayed in this page.</p> <p> Please read the following table to get familiar with the interface elements and their functions.</p> | |
| ①: Stitch shape display field | → Display the current selected pattern stitch |
| ②: File selection button | → Select the pattern corresponding to the file number. |
| ③: Page turning button | → Browse the next page. |
| ④: New file button | <p>→ Click it to pop up keypad, enter digital file name and confirm it, a new null file will be created in SD card.</p> <p> This button is shown only when selecting to export the pattern from operating box to SD card.</p> |
| ⑤: Return button | → Abort the current selection and return to the previous interface |
| ⑥: Confirm button | → Confirm the current selection and return to the previous interface |

9.8 Access setting

 **For professionals only.**

 There are three access levels:

Access 0  : Access to all functions

Access 1  : Test run function is inaccessible



Access 2  : Following functions are inaccessible:

- Universal information setting
- Restore default setting

- Operation panel parameter setting
- System parameter setting
- Touch screen calibration
- Test run function

 **The default access level is Access 1.**

9.8.1 Access setting

 In System Management Setting Interface, click  to enter Access Setting Interface.

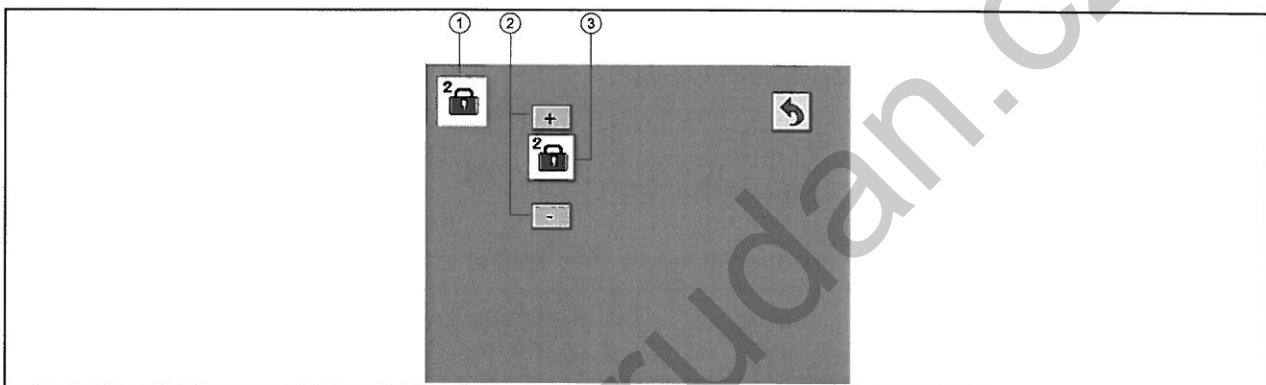



 **Please follows the following steps to revise access setting.**

①: Current access level display

②: Access level selection



→ Click it to switch access level in ,  and .

③: Access level setting



→ After selecting access level in ②, click this button to confirm setting.







→ If access  is set, no password is required.

→ If access  is set, call Keypad Setting Interface and enter the password for Access 1.

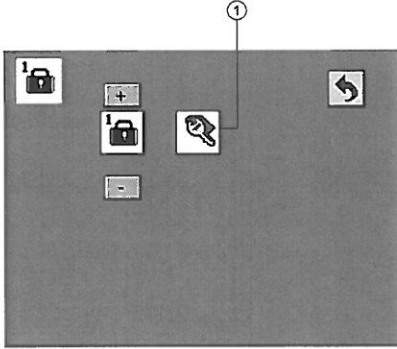

 **The default password of Access 1 is 1111.**

9.8.2 Access password revise

 In Access Setting Interface, select Access 1  and enter the correct password to enter the following interface:



| | |
|--|---|
|  | <p>①: Click password revise button  to enter new password and make sure the password revise button changes into , then it is prompted to reenter the new password;</p> <p>②: Click password revise button  to reenter the same new password and confirm it, now the password revise button  disappears, it means the password revision is successful.</p> |
| <p> Password revision function is unavailable for Access 2.</p> | |

10 System information setting (I interface)

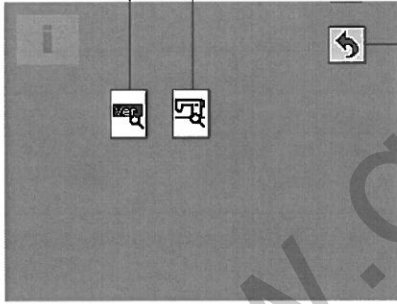
 In Main Interface, click  to enter System Information Setting Interface.

| | |
|---|---|
|  | <p>A: Software version inquiry button. Click it to enter software version inquiry interface;</p> <p>B: System operation monitor button. Click it to enter system operation monitor interface;</p> <p>C: Return button</p> |
|---|---|

10.1 Software version inquiry

 In System Information Setting Interface, click  to enter Software Version Inquiry Interface.

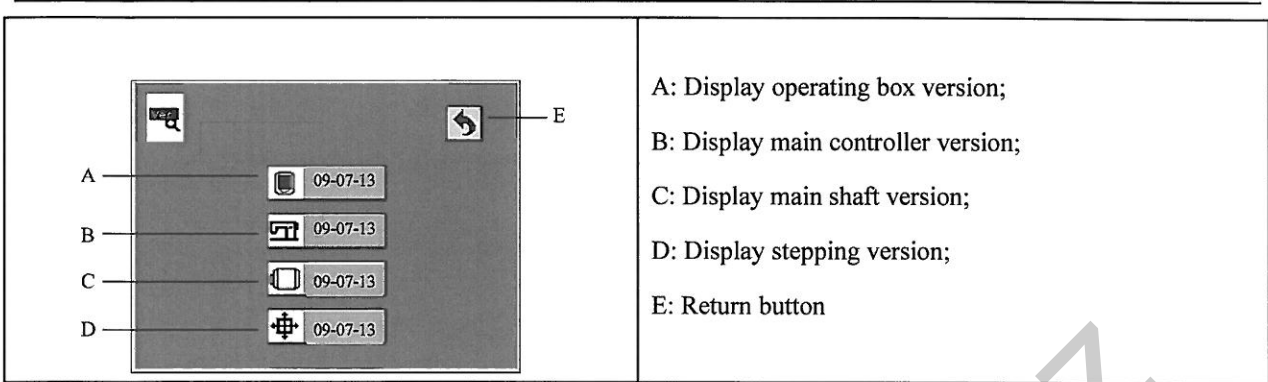

10.2 System operation monitor

In System Information Setting Interface, click to enter System Operation Monitor Interface.

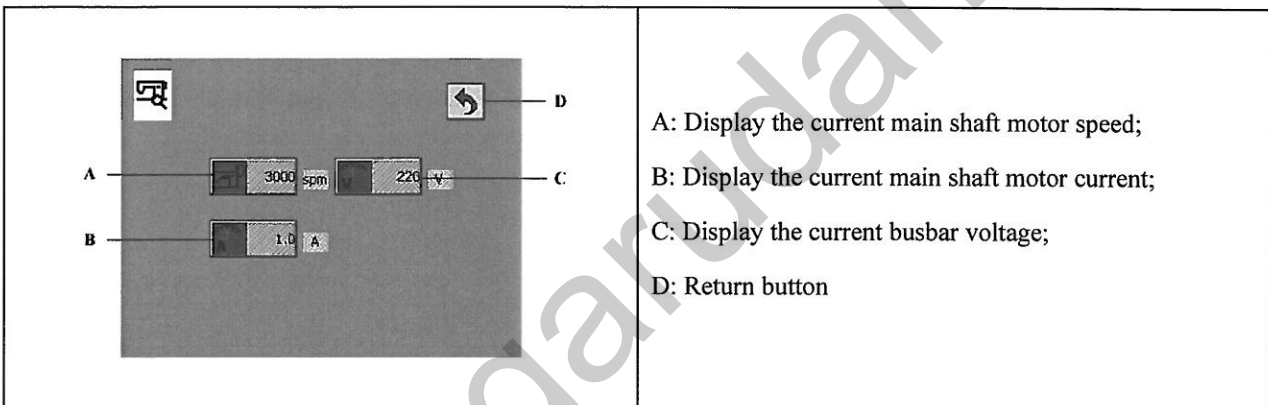

11 Abnormalities

11.1 Alarms

11.1.1 Customization synchronization

If the operating box is replaced or customization operation is conducted by the user, the synchronization prompt will appear upon the next power on. See the following figure:

User can conduct operations as prompted in Figures 1 to 3.

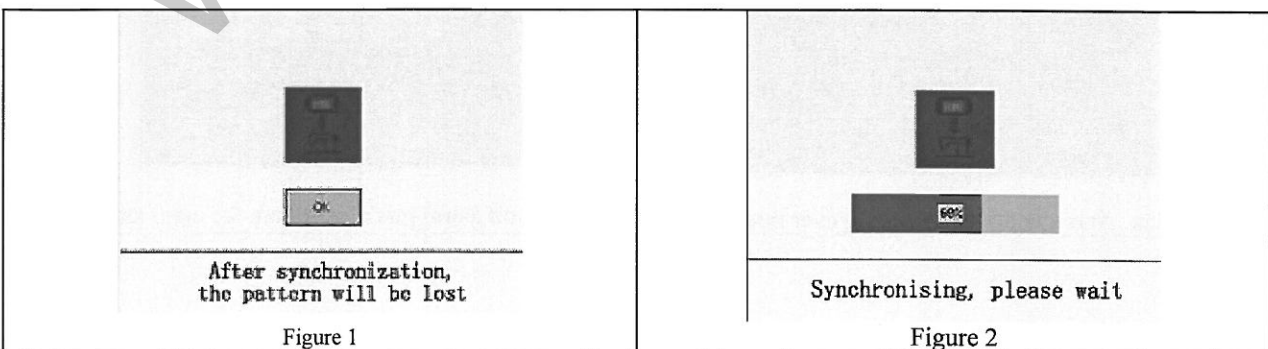

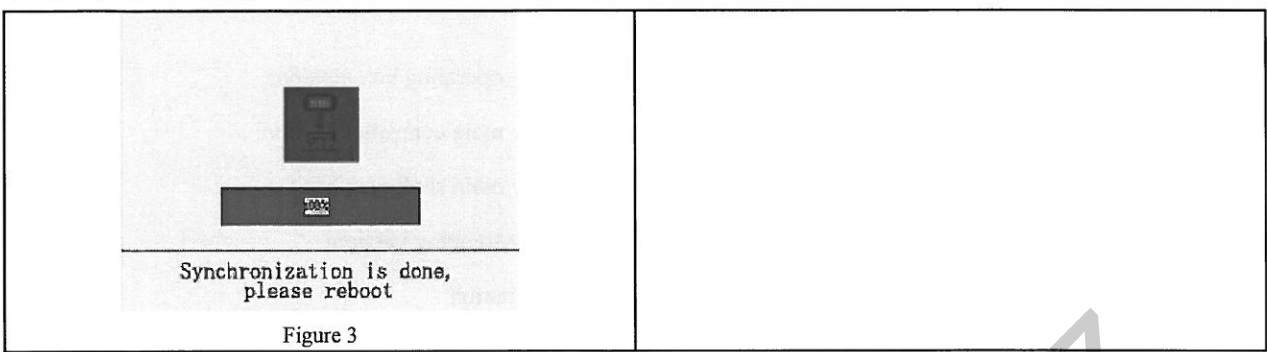

11.1.2 Non upper needle stop position alarm

☞ When the power is turned on, if the needle is not at the upper needle stop position, the operating box will stay at the following interface:

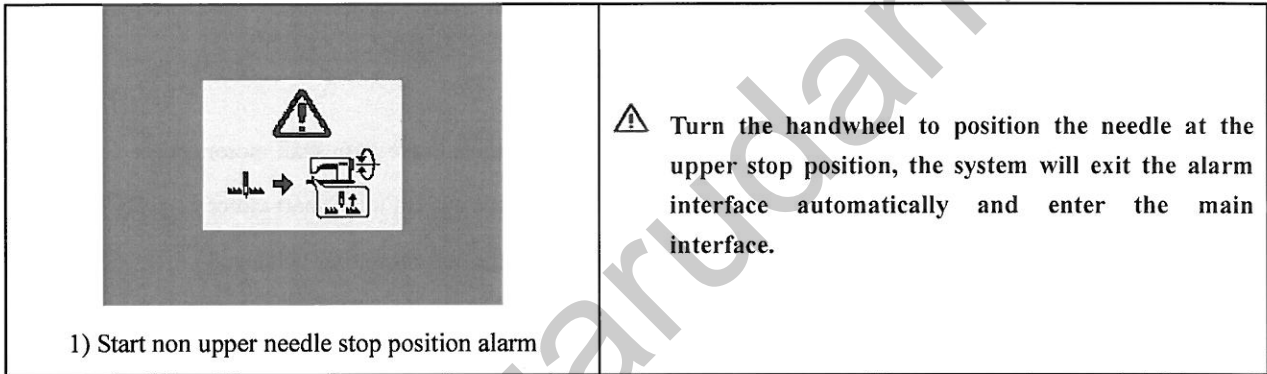

11.1.3 Data over limit alarm

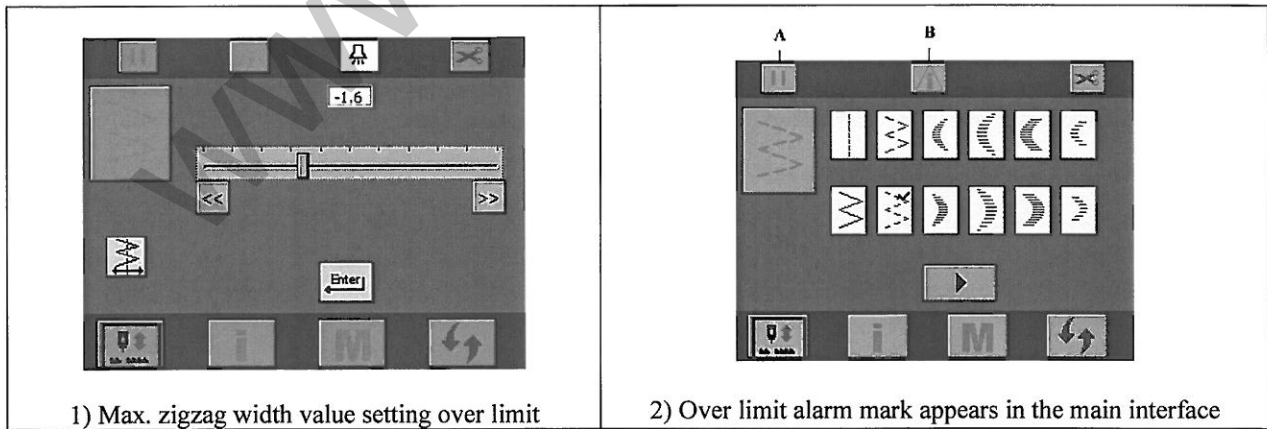

☞ When the reference line position or the max. zigzag width value exceeds the system limit, an alarm mark  will appear in the status bar of the page, which lasts after returning to the main interface.

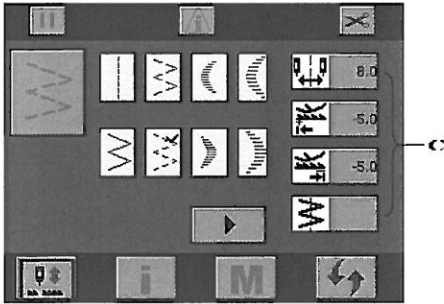



3) After clicking the alarm mark, universal sewing information prompt appears

⚠ Assume that 4-point zigzag width data is over limit:

- 1) After data setting, over limit alarm interface will appear;
- 2) After clicking OK and returning to main interface,
 - A: In case of over limit, the system operation will be disabled, stop/run button appears  state and cannot be set until the alarm is reset;
 - B: In case of over limit, over limit alarm state button  will appear;
- 3) C: Click , **Universal Sewing Information Prompt** appears.

👉 Universal sewing information prompt

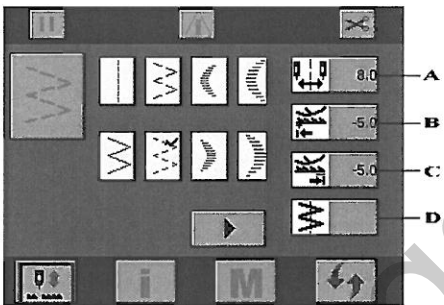





- A: Display system zigzag width setting;
- B: Display system forward feeding volume setting;
- C: Display system reserve feeding volume setting;
- D: Display system reference line setting.

⚠ The displayed contents depend on specific parameters. See [System Management Setting](#) → [Universal Parameter Setting](#).

👉 Data over limit alarm reset

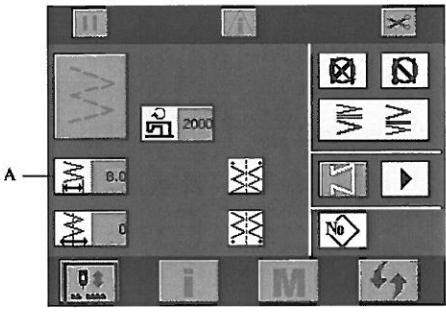
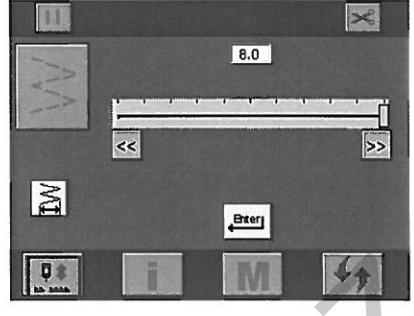
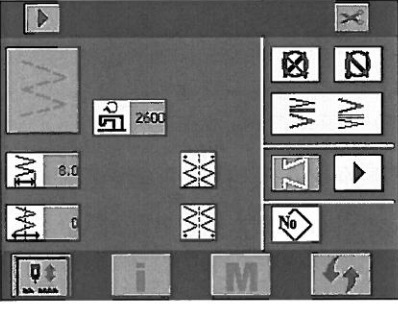
Example: Zigzag width over limit.

If the original system zigzag width is 10mm, 4-point zigzag pattern zigzag width is 9mm and the revised system zigzag width is 8mm, WHEN returning to the main interface, the alarm in this section will appear. Data over limit alarm reset method:

| | |
|---|--|
|  <p>1) Pattern attribute interface</p> |  <p>2) Slipper Setting Interface-zigzag width setting</p> |
|  <p>3) After returning</p> | <p>⚠ Assume that 4-point zigzag width data is over limit:</p> <ol style="list-style-type: none"> 1) Enter pattern attribute interface; 2) Click button A to enter Slipper Setting Interface, now the max. value of the slipper is the system zigzag width set value, adjust the slipper as required, then click  to return. 3) After returning, the  mark in the status bar of the interface disappear, and stop/run button changes from  to . |

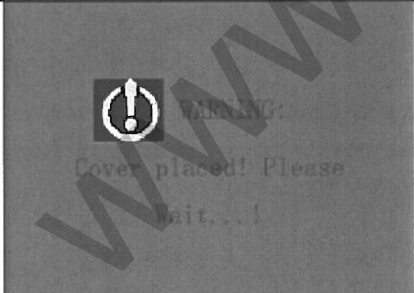

11.1.4 Head lift alarm

 When the head is in lift state, the operating box prompts head lift alarm as follows:

| | |
|---|---|
|  | <p><<<Head Lift Alarm Interface.</p> <p>→ When the head position is recovered, the head lift alarm will be reset automatically.</p> <p>⚠ If this alarm appears upon startup, check the hardware and set <u>system parameter</u> P40 correctly.</p> |
|---|---|

11.2 Troubles

Example: E-03 solenoid overcurrent trouble

| | |
|---|---|
|  | <p><<< Error Prompt Interface.</p> <p> For fault codes and solutions, see VIII. List of troubles</p> |
|---|---|

VI. Operating box parameter table

| No. | Item | Description | Setting range | Default setting |
|-----|--------------------|---|---------------|-----------------|
| H01 | Key sound enable | 0: Disable; 1: Enable | 0/1 | 1 |
| H02 | Backlight | 5-55 | 5-55 | 30 |
| H03 | Contrast | 5-55 | 5-55 | 30 |
| H04 | Alarm sound enable | 0: Disable; 1: Enable | 0/1 | 1 |
| H05 | Language selection | 0: Chinese; 1: English; 2: Portuguese; 3: Spanish; 4: Turkish | 0-4 | 0 |

VII. Advanced parameter table

| No. | Item | Description | Setting range | Default setting |
|-------|--------------------------------------|---|---------------|-----------------|
| P01 | Soft start | Soft start setting; 0: No soft start; 1-9: Soft start stitch number | 0~9 | 2 |
| P02 | Soft start speed | Soft start speed | 150~2500 spm | 1000 |
| * P03 | Low speed | To set the pedal to the lowest speed. | 150~300 spm | 200 |
| P04 | Pedal high speed | The highest speed of the pedal | 200~5500 spm | 4000 |
| P05 | To select the pedal curve selection. | To select pedal curve; 0: Standard; 1: Slow; 2: Fast | 0/1/2 | 0 |
| P06 | Trigger sewing speed | Trigger sewing (single sewing) speed | 200~5500 spm | 3000 |
| * P07 | Bar-tacking speed | Bar-tacking speed | 150~2500 spm | 1500 |
| * P08 | To set the speed | To set the speed upon thread trimming. | 150~300 spm | 200 |

| | | | | |
|-------|---|---|-----------|-----|
| | upon thread trimming. | | | |
| P11 | Needle stop position | To set the needle bar position when the sewing machine is stopped; 0: Lower needle stop position; 1: Upper needle stop position | 0/1 | 0 |
| P12 | Operating box compensation key switch function | Operating box compensation key function switching; 0: Compensate half stitch; 1: Compensate 1 stitch | 0/1 | 0 |
| P 15 | Presser foot lift function selection | To select presser foot lift function; 0: Inactive; 1: Active | 0/1 | 1 |
| P16 | Neutral presser foot lift function | To select automatic presser foot lift function when pedal is at neutral position; 0: Inactive; 1: Active | 0/1 | 0 |
| P17 | Presser foot lift hold time | Lift stand-by time limit for solenoid type auto presser foot lift assembly | 2~250 s | 10 |
| P18 | To set the presser foot lift full voltage time. | To set the presser foot lift full voltage time. | 50~250 ms | 150 |
| * P19 | To set the presser foot output duty ratio. | To set the presser foot output duty ratio. | 0~100 | 40 |
| * P20 | Presser foot lowering delay time | The time for presser foot lowering after the pedal is stepped. | 0~250 ms | 150 |
| P21 | Presser foot soft lowering function | To select presser foot lowering mode; 0: Fast lowering; 1: Slow lowering | 0/1 | 0 |
| P22 | Enabled automatically after thread trimming | To select the function of automatic presser foot lift after thread trimming; 0: Inactive; 1: Active | 0/1 | 1 |
| P23 | Pedal command mode after thread trimming | To set pedal command mode after thread trimming; 0: Thread trimming command does not allow presser foot lift; 1: Thread trimming command allows presser foot lift | 0/1 | 1 |

| | | | | |
|-------|---|--|---------------------|-----|
| P25 | Front bar-tacking speed selection | To select the speed for front bar-tacking; 0: Pedal speed; 1: Set reverse speed | 0/1 | 1 |
| P26 | Stop after front bar-tacking | To select the function of machine stop after front bar-tacking; 0: Inactive; 1: Active | 0/1 | 0 |
| P30 | Thread take-up function | To select thread take-up function; 0: Inactive; 1: Active | 0/1 | 1 |
| P31 | Thread take-up delay time | To set thread take-up delay time | 0~250 ms | 170 |
| P32 | To set the thread wiping hold time. | To set the thread wiping hold time | 0~250 ms | 70 |
| P33 | Thread releasing upon the start of sewing | To set the function of thread releasing upon the start of sewing; 0: Inactive; 1-9: To set the number of stitch for activating thread releasing upon the start of sewing | 0~9 | 0 |
| * P34 | Reversal of needle lift | To select the function of reversal of needle lift after thread trimming; 0: Inactive; 1: Active | 0/1 | 0 |
| * P35 | Reversal of needle lift angle | To set the angle for reversal of needle lift (the angle reversing from upper needle stop position) | 0-45 (degree) | 20 |
| P40 | Head lift switch signal mode | To set head lift switch signal mode; 0: NO signal; 1: NC signal | 0/1 | 0 |
| * P41 | Pedal analog corrective command | To set pedal analog corrective command; 0: Inactive; 1: Active | 0/1 | 0 |
| * P42 | Pedal stroke upon start | To set the pedal stroke from start position to neutral position | 10-50 (0.1 degree) | 25 |
| * P43 | Pedal stroke upon acceleration | To set the pedal stroke from acceleration position to neutral position | 10-100 (0.1 degree) | 50 |
| * P44 | Pedal stroke at highest rotation speed | To set the pedal stroke from highest speed position to neutral position | 10-150 (0.1 degree) | 125 |

| | | | | |
|-------|---|---|-----------------------|------|
| * P45 | Pedal stroke upon presser foot lift | To set the pedal stroke from presser foot lift position to neutral position | -100-10 (0.1 degree) | -20 |
| * P46 | Pedal stroke upon presser foot lowering | To set the pedal stroke from presser foot lowering position to neutral position | 5-50 (0.1 degree) | 10 |
| * P47 | Pedal stroke 1 upon thread trimming | To set the pedal stroke from thread trimming position to neutral position with presser foot lift disabled | -100~-10 (0.1 degree) | -25 |
| * P48 | Pedal stroke 2 upon thread trimming | To set the pedal stroke from thread trimming position to neutral position with presser foot lift enabled | -100~-10 (0.1 degree) | -60 |
| * P49 | Pedal neutral point | To precisely adjust the pedal neutral point. | -15~15 (0.1 degree) | 0 |
| * P50 | Highest speed | To set the highest speed of the head. | 200~5500 spm | 5000 |

* The marked items are functions for maintenance. Any change to the factory setting may damage the machine or degrade the machine performance. Any change must be made under the instruction of professionals. However, to increase the function and performance of the sewing machine, the functional settings can be changed from time to time.

Details of system function setting:

1. Soft start function (parameter P01, P02)

For a short stitch length or thick needle, since the bobbin and needle threads can not be sewn together when sewing is just started, limiting the initial speed of sewing machine can improve the sewing reliability.

P01 To set the number of stitches for soft start.

0 Disabled.

1~9 To set the number of stitches for soft start so as to limit the sewing speed.

P02 To set the soft start speed.

2. Sewing speed adjusting function (parameter P03-08)

1) Highest speed of free sewing (parameter P04)

This setting is used to set the highest speed for free sewing.

Note: If this value is set too high, the service life of the sewing machine will be reduced.

2) Bar-tacking speed setting (parameter P07)

Speed for bar-tacking, including front bar-tacking, back bar-tacking and toandfro bar-tacking.

Note: If the back tacking speed is set too high, the quality of stitches may degrade.

3) Fixed length sewing trigger sewing speed setting (parameter P06)

For fixed length sewing, the parameter allows the setting of sewing speed when trigger function is selected.

Trigger function refers to the function of finishing the set stitches of the current section by stepping the pedal once.

4) Low speed setting (parameter P03)

Pedal speed upon start. When it is adjusted to a proper value, compensation can be conducted by pedal conveniently.

5) Thread trimming speed setting (parameter P08)

To set the sewing speed upon thread trimming.

Note: low or high thread trimming speed can affect the reliability of thread trimming and damage mechanical parts.

6) Pedal speed adjustment performance setting (parameter P05)

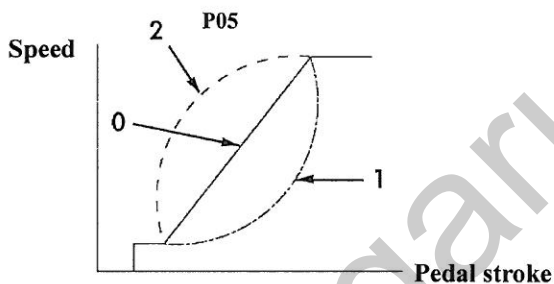

User can customize the speed adjustment performance of the pedal. To start up quickly, select P05=2; to start up smoothly, select P05=1.

3. Stop needle position setting (parameter P11)

To set the needle bar position when the sewing machine is stopped.

- 0 Lower needle stop position
- 1 Upper needle stop position

4. Operating box compensation key function switching (parameter P12)

This parameter allows the switching of compensation key function on the operating box, i.e. compensate half stitch or one stitch.

- 0 Compensate half stitch
- 1 Compensate 1 stitch

5. Presser foot lift function selection (parameter P15)

To select presser foot lift function.

When the presser foot lift solenoid is not connected, please set the parameter to 0, otherwise a time lay will happen to the sewing machine.

0 Presser foot lift function disabled

1 Presser foot lift function enabled

6. Neutral presser foot lift function (parameter P16)

To set automatic presser foot lift function when pedal is at neutral position.

When the presser foot is lifted, it will lower after the time set by P17. To lift it again, step on the pedal to move it away from and then return to the neutral position.

7. Presser foot lift solenoid hold time setting (parameter P17)

This parameter is used to set the presser foot lift hold time. However, the service life of the solenoid will be reduced due to excessively long closing of solenoid.

When the presser foot is lifted, the solenoid will be turned off automatically to lower the presser foot when the time set by P17 elapses.

8. Neutral presser foot lowering delay sewing function (parameter P20)

When the presser foot lift solenoid is engaged, step the pedal to start operation. Since the solenoid takes time to release, the sewing machine may operate before the presser foot pressing the fabric so as to affect the sewing effect. By setting this parameter, the presser foot lift release time can be compensated appropriately.

9. Setting of pedal command after thread trimming (parameter P23)

To set the command of presser foot lift by stepping pedal after thread trimming.

This function is designed to allow presser foot lift after thread trimming.

10. Front bar-tacking speed switching selection (parameter P25)

To select the front bar-tacking speed controlled by pedal or set by parameter P07.

11. Stop after front bar-tacking (parameter P26)

After front bar-tacking, the sewing is stopped, now the sewing direction can be changed.

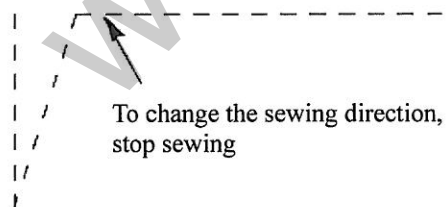

12. Reversal of needle lift (parameter P34, P35)

After thread trimming, reverse the sewing machine to lift the needle to near the top dead point. Parameter No. 35 can adjust the reversal angle.

This function is used in case the fabric touches the needle and cannot exit smoothly after thread trimming when

sewing heavy fabrics.

Note: When the needle is moved nearly to the top dead point, further sewing will cause the thread loosened. In this case, adjust the length of the thread.

13. Analog pedal initial position correction (parameter P41)

When parameter P41 is set to 1, pedal initial position is corrected.

Note: the pedal should be released and not stressed in correction, otherwise the correction will be in accurate and E-08 fault will be alarmed.

14. Head highest speed setting (parameter P50)

To set the highest sewing speed of the head. For new head in running-in stage, this speed should not be set high.

www.garudan.cz

VIII. List of troubles

| Operating box display | Abnormality | Solution |
|-----------------------|---|---|
| E-01 | Failed communication with stepping CPU | Turn off the power |
| E-02 | Failed communication with servo CPU | Turn off the power |
| E-03 | Solenoid overcurrent trouble | 1. Turn off the power; 2. Check the solenoid |
| E-04 | Solenoid abnormal on state | 1. Turn off the power; 2. Check the solenoid |
| E-05 | Upper needle stop position signal failure | 1. Check whether the needle stop sensor plug falls off; 2. Check whether the needle stop sensor plug is broken by the head |
| E-06 | Lower needle stop position signal failure | 1. Check whether the needle stop sensor plug falls off; 2. Check whether the needle stop sensor plug is broken by the head |
| E-07 | Relay failure | Turn off the power |
| E-08 | Analog pedal self setting failure | Retest with pedal unstressed |
| E-09 | Pedal identification code error | Check whether the pedal plug is loosened. |
| E-10 | FLASH identification code error | Check main control panel extension Flash. |
| E-11 | FLASH read-write failure | Check main control panel extension Flash. |
| E-13 | FLASH overtime failure | Check main control panel extension Flash. |
| E-14 | Pattern shape data error | Check operating box pattern shape data |
| E-21 | Zigzag stepping overcurrent trouble | 1. Turn off the power; 2. Check the zigzag step motor |
| E-22 | Fabric feeding stepping overcurrent trouble | 1. Turn off the power; 2. Check the fabric feeding step motor |
| E-24 | Zigzag zero adjustment error | 1. Check whether the connector falls off; 2. Check whether the zigzag sensor is damaged |
| E-25 | Fabric feeding zero adjustment error | 1. Check whether the connector falls off; 2. Check whether the fabric feeding sensor is damaged |
| E-26 | Zigzag motor initialization failure | |
| E-27 | Fabric feeding motor initialization failure | |
| E-28 | 85V voltage failure | |
| E-29 | Zigzag step motor overtemperature | |
| E-30 | Fabric feeding step motor overtemperature | |
| E-41 | HALL signal initialization failure | 1. Check whether the connector falls off; 2. Check whether the needle motor sensor plug is broken by the head |
| E-42 | HALLA signal lost | 1. Check whether the connector falls off; |

| | | |
|------|--------------------------------------|---|
| | | 2. Check whether the needle motor sensor plug is broken by the head |
| E-43 | Motor initialization failure | 1. Check whether the connector falls off; 2. Check whether the needle motor sensor plug is broken by the head |
| E-44 | Over-current of hardware | 1. Turn off the power; 2. Check whether the grounding is reliable |
| E-45 | Over-current of software | Turn off the power |
| E-46 | Motor blockage | 1. Check whether the motor power plug falls off; 2. Check whether the motor sensor plug falls off; 3. Check whether the sewing machine head is seized |
| E-47 | Over-speed | 1. Turn off the power; 2. Check whether the motor connection and sensor are normal |
| E-48 | Reverse rotation | 1. Turn off the power; 2. Check whether the motor connection and sensor are normal |
| E-50 | Over-voltage upon machine stop | Check whether the supply voltage is high |
| E-51 | Over-voltage upon operation | Check whether the supply voltage is high |
| E-52 | Under-voltage upon machine stop | Check whether the supply voltage is low |
| E-53 | Under-voltage upon operation | Check whether the supply voltage is low |
| E-54 | The brake circuit may fail. | Turn off the power |
| E-55 | Failure of current detection circuit | Turn off the power |
| E-60 | SCI communication failure | Check whether the operating box connection is loosened |
| E-61 | Operating box memory error | Turn off the power |
| E-62 | Operating box self-check error | Turn off the power |
| E-15 | Internal failure | Turn off the power |
| E-16 | | |
| E-20 | | |
| E-23 | | |
| E-40 | | |

www.garudan.cz